

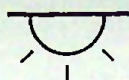

55



XM  
550-000/1

1

**FONCTION :  
ECLAIRAGE ET EQUIPEMENTS  
INTERIEURS**

*LISTE DES SCHEMAS*



## ECLAIRAGE INTERIEUR

NUMERO	DIRECTION	VALIDITE	DESIGNATION
550-00/05	Gauche	05/89 → → 07/93	<b>VEHICULE sans AFFICHEUR GAUCHE</b>
550-00/05a	Gauche	07/93 →	Evolution a : Modification masses faisceau CL.
550-00/10	Gauche	05/89 → → 07/93	<b>VEHICULE avec SILHOUETTE AUTO</b>
550-00/10a	Gauche	07/93 →	Evolution a : Modification masses faisceau CL.
550-00/20	Gauche	05/89 → → 07/90	<b>VEHICULE avec MATRICE DE POINTS</b>
550-00/20a	Gauche	07/90 →	Evolution a : Présence d'un relais temporisateur (10mn)
550-00/20b	Gauche		Evolution b : Modification masses faisceau AV.
550-00/20c	Gauche	07/93 →	Evolution c : Modification masses faisceau CL.
550-0/05	Gauche	07/93 →	<b>XM BREAK sans AFFICHEUR GAUCHE</b>
550-0/10	Gauche	07/93 →	<b>XM BREAK avec SILHOUETTE AUTO</b>
550-0/20	Gauche	07/93 →	<b>XM BREAK avec MATRICE DE POINTS</b>



55



XM  
550-00/05a

5

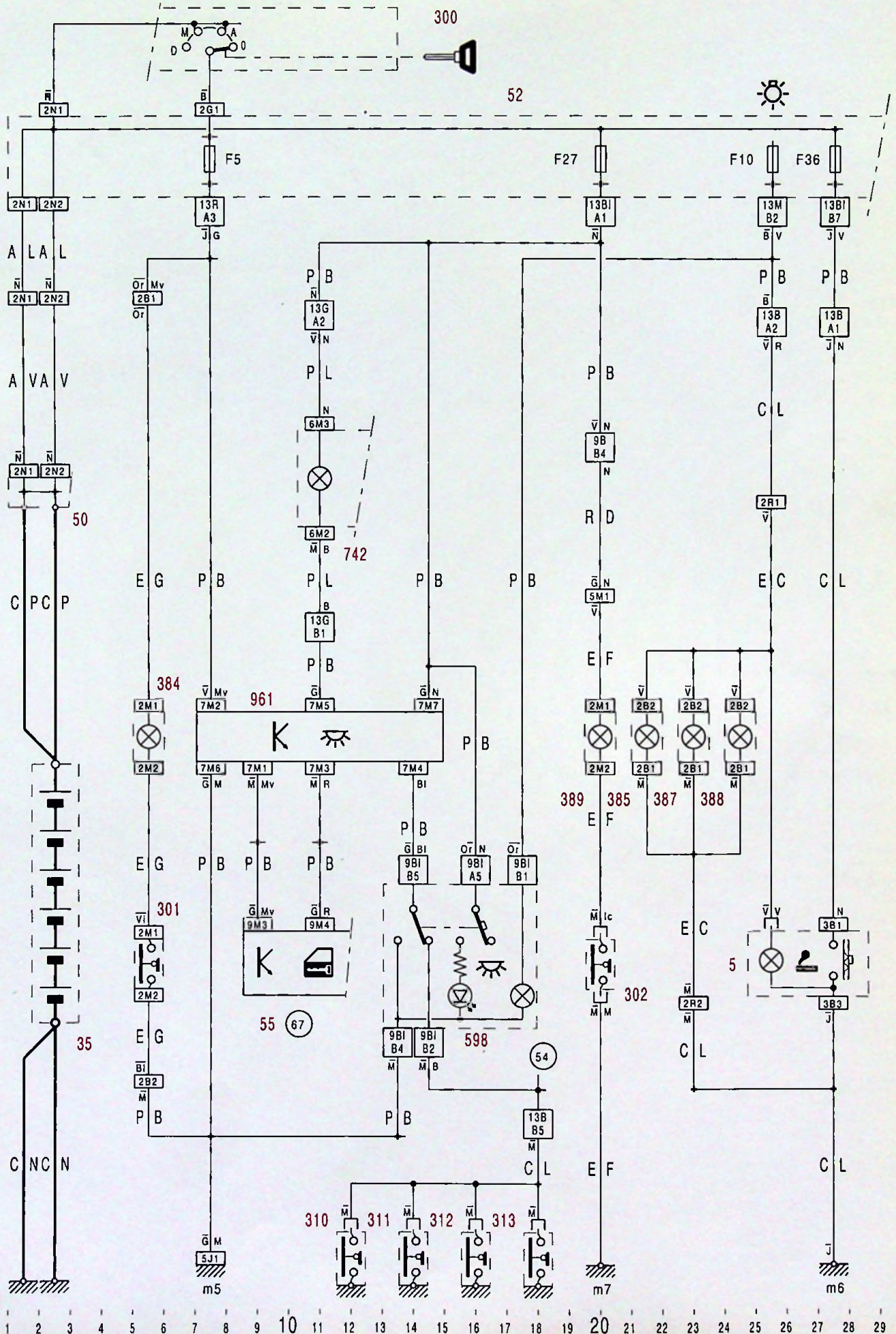



55



XM  
550-00/10a

6

7

XM  
550-00/10a



55

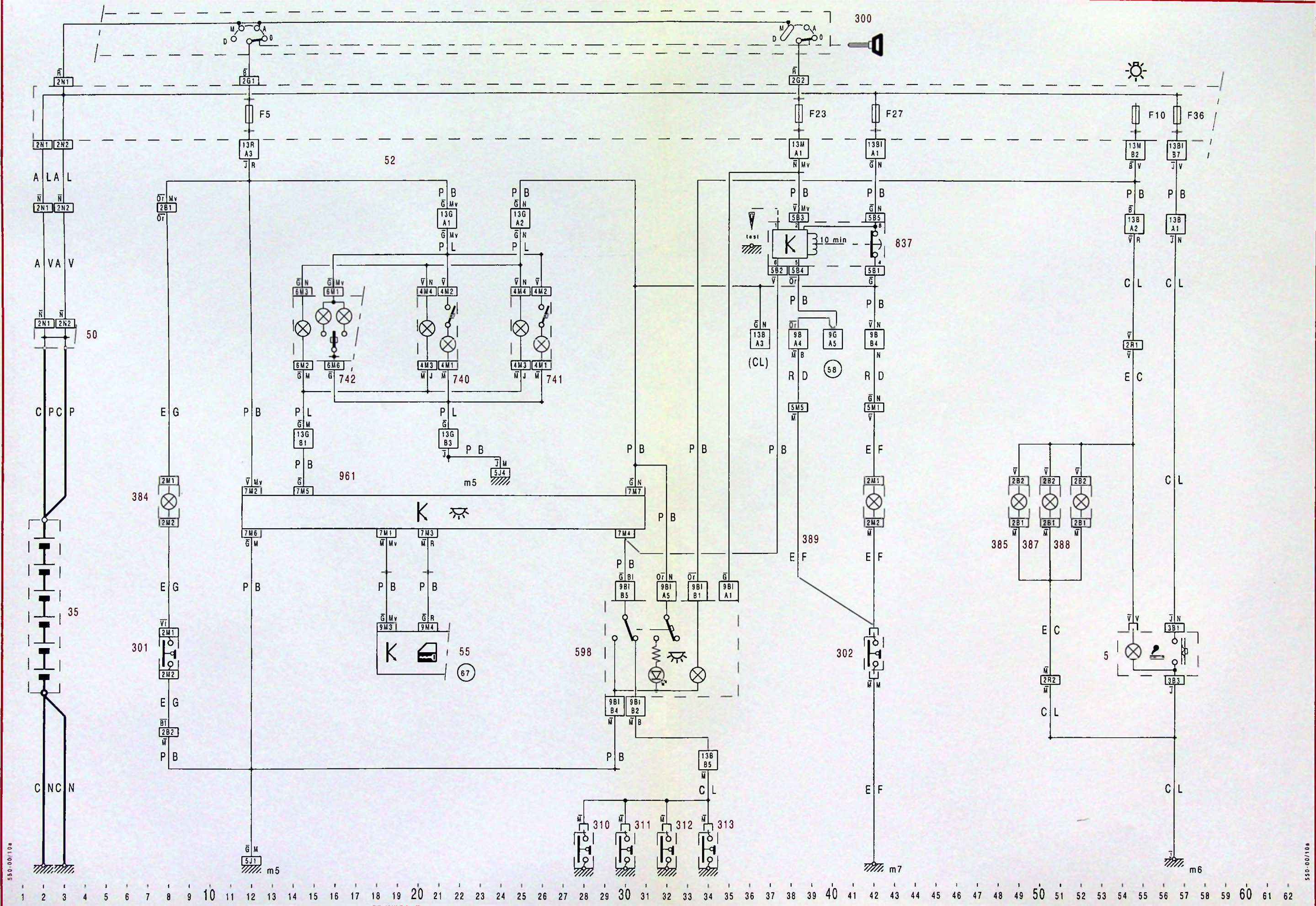

550-00/10a

550-00/10a



55

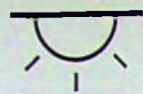

XM  
550-00/20

3

4

XM  
550-00/20

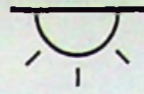

55

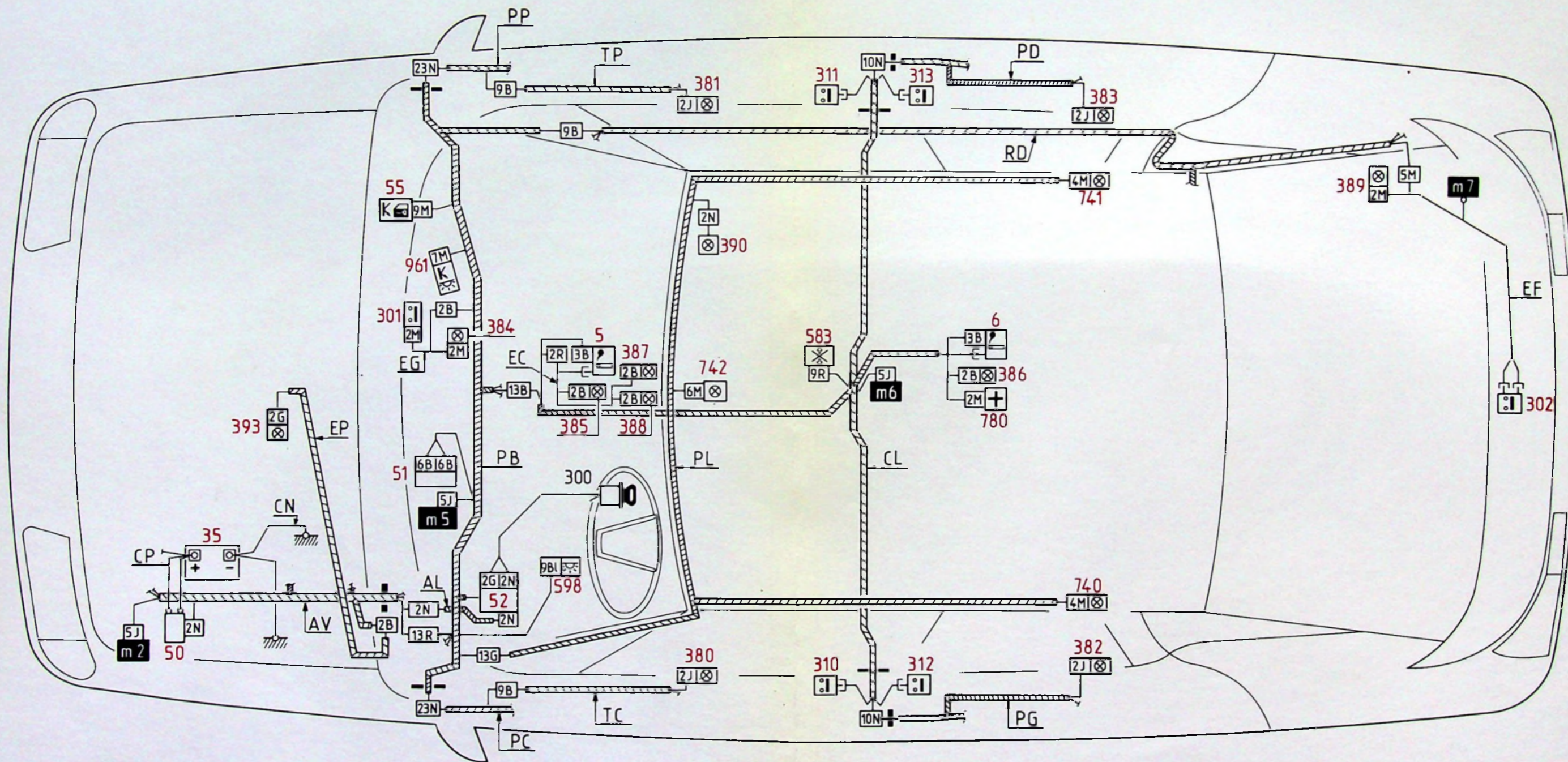



55

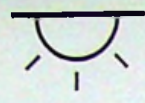

XM  
550-00/20

6

7

XM  
550-00/20

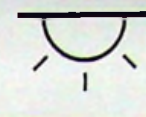

55

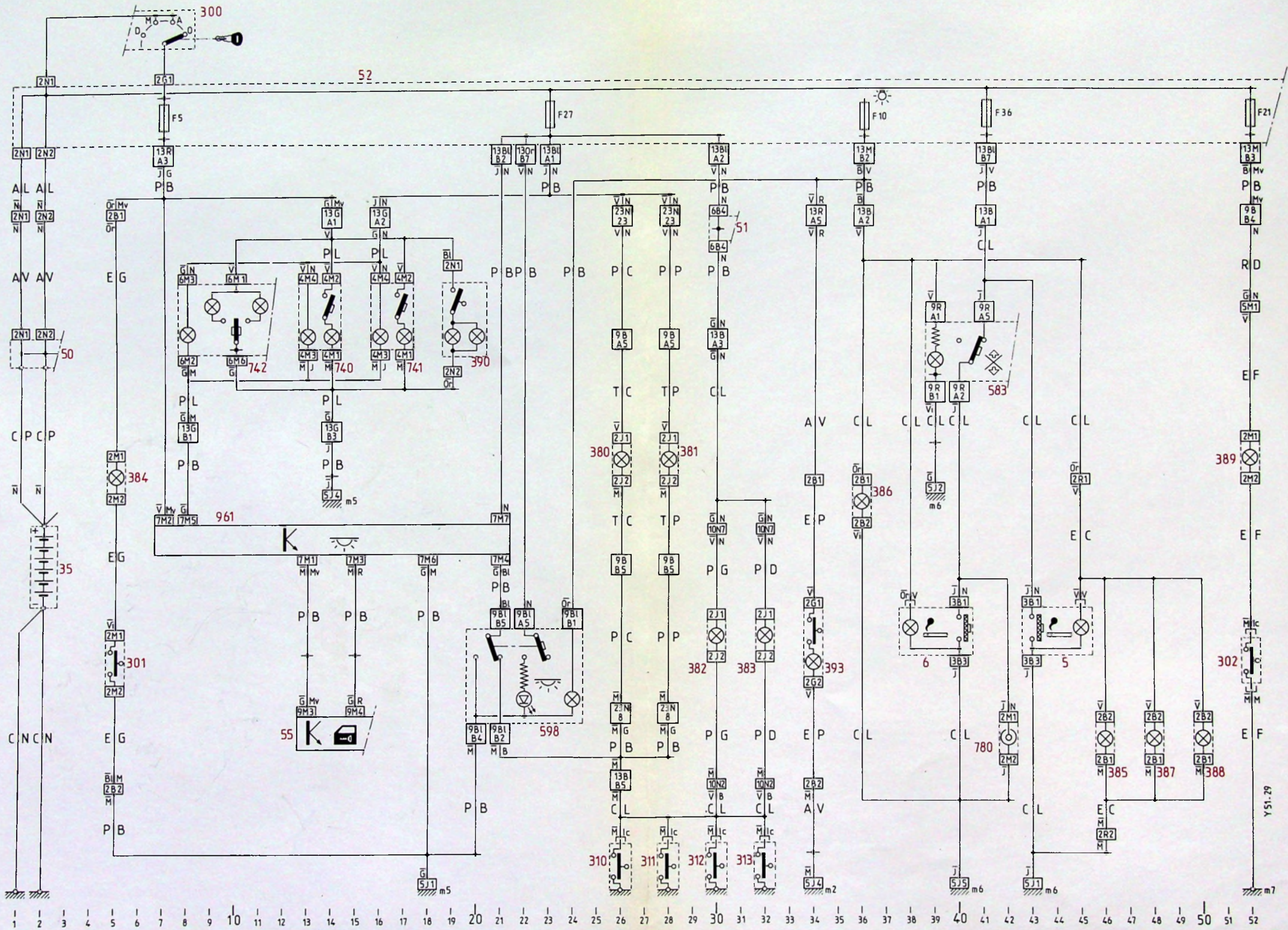



55



XM  
550-00/20c

6

7

XM  
550-00/20c

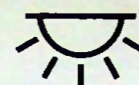

55

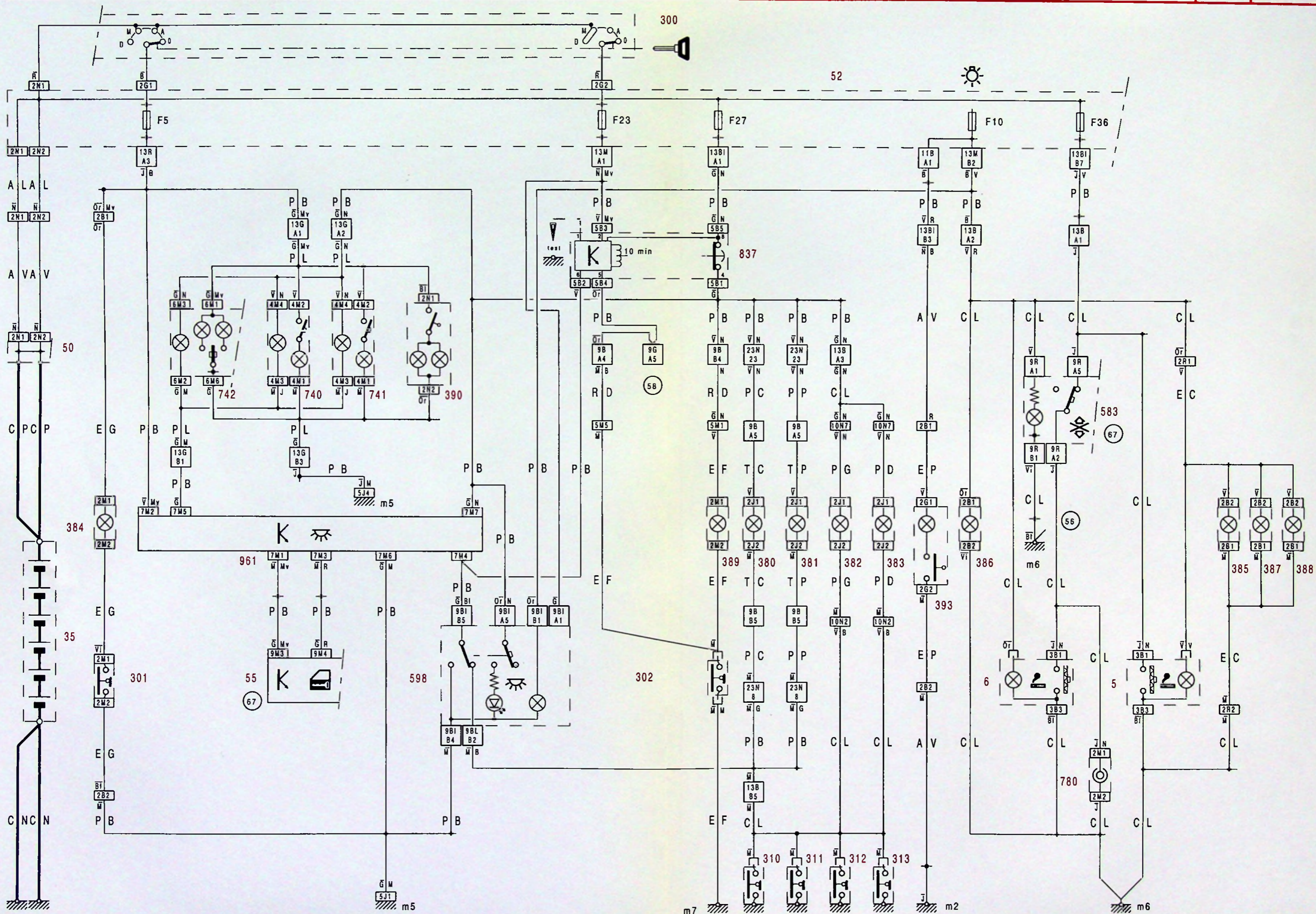

550-00/20c

550-00/20c

1 2 3 4 5 6 7 8 9 10 11 12 13 14 15 16 17 18 19 20 21 22 23 24 25 26 27 28 29 30 31 32 33 34 35 36 37 38 39 40 41 42 43 44 45 46 47 48 49 50 51 52 53 54 55 56 57 58 59 60 61 62



55



XM  
550-0/05

5

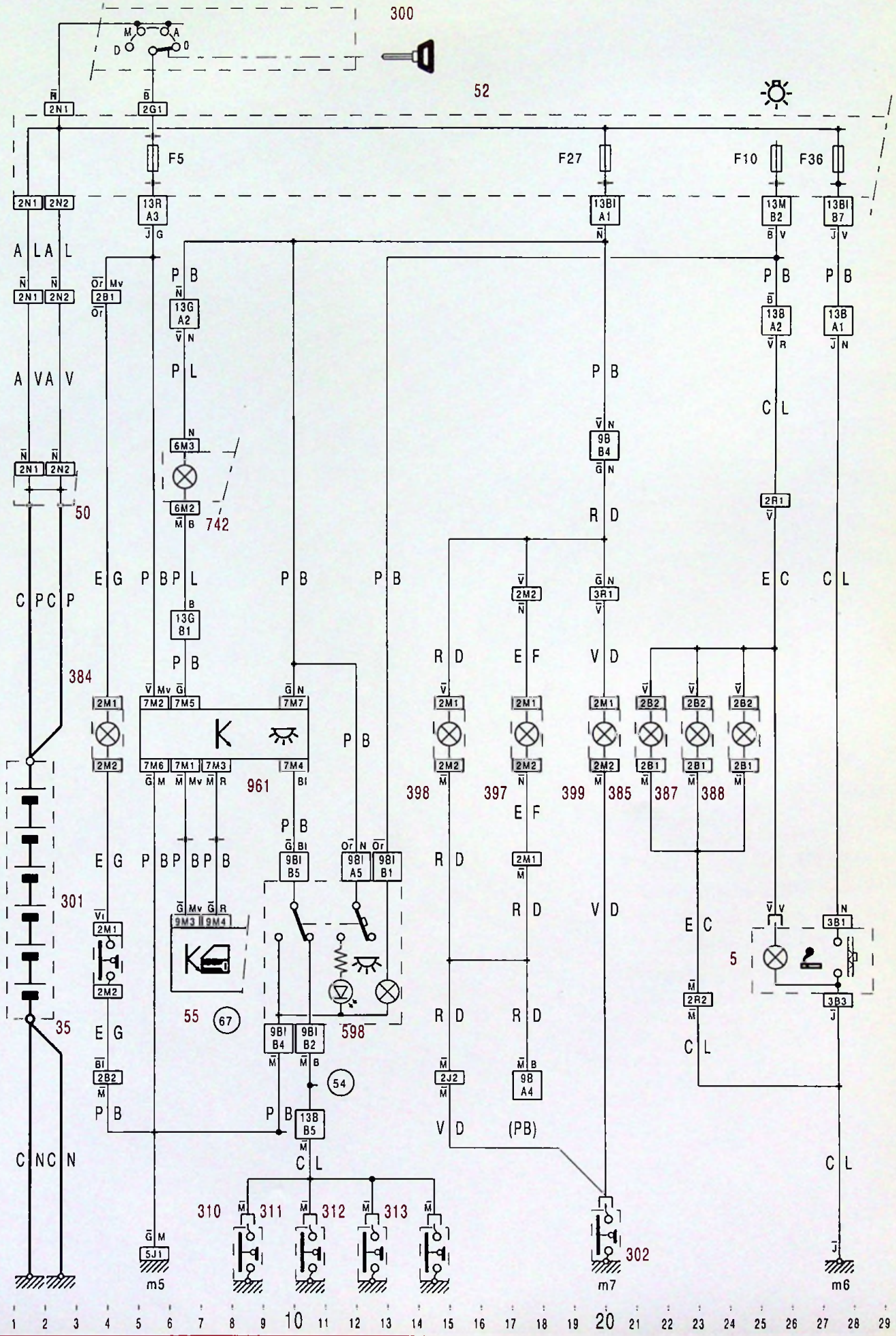





55



XM  
550-0/10

6

7

XM  
550-0/10



55

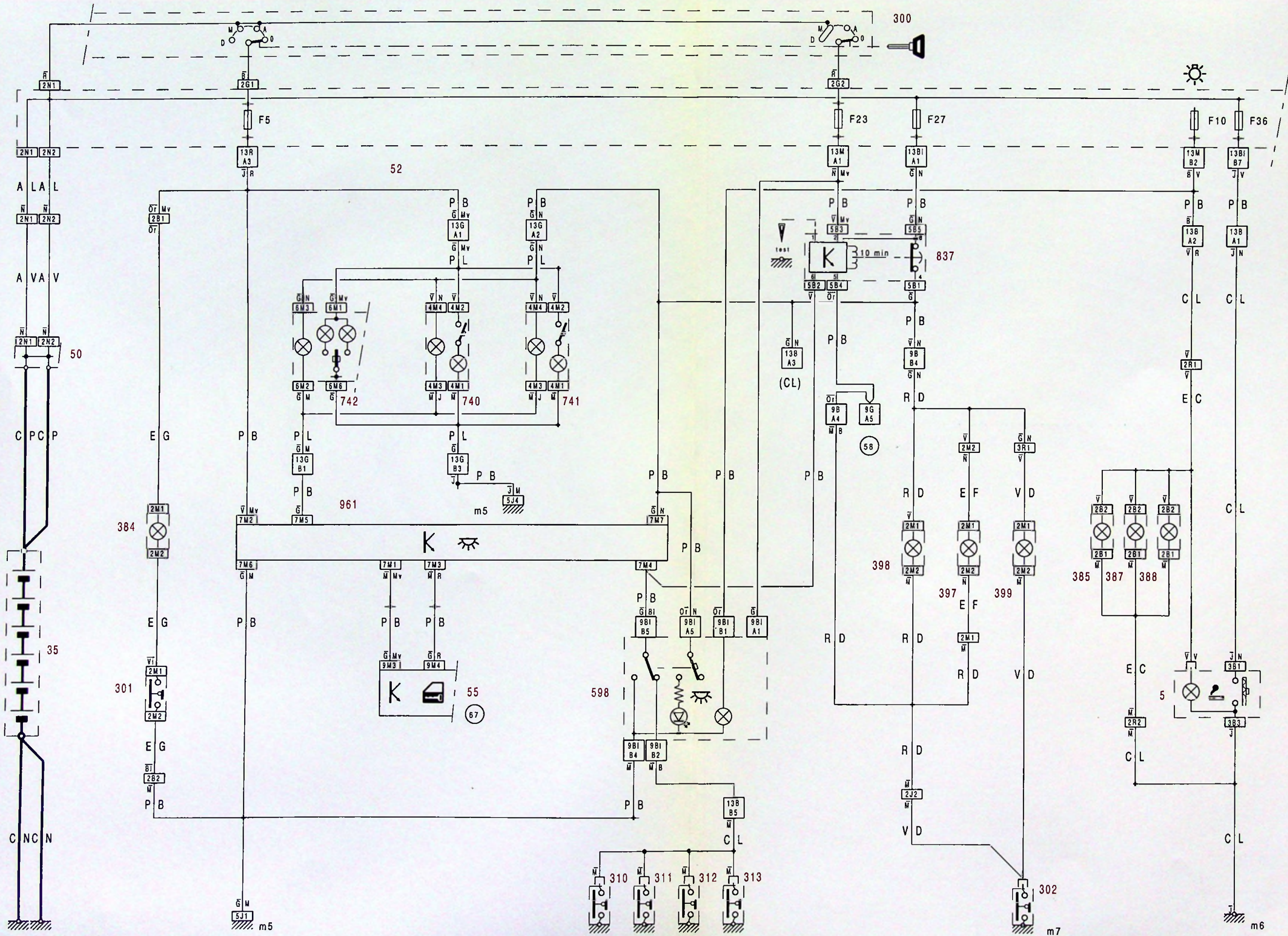

550-0/10

550-0/10

1 2 3 4 5 6 7 8 9 10 11 12 13 14 15 16 17 18 19 20 21 22 23 24 25 26 27 28 29 30 31 32 33 34 35 36 37 38 39 40 41 42 43 44 45 46 47 48 49 50 51 52 53 54 55 56 57 58 59 60 61 62



55



XM  
550-0/20

6

7

XM  
550-0/20



55

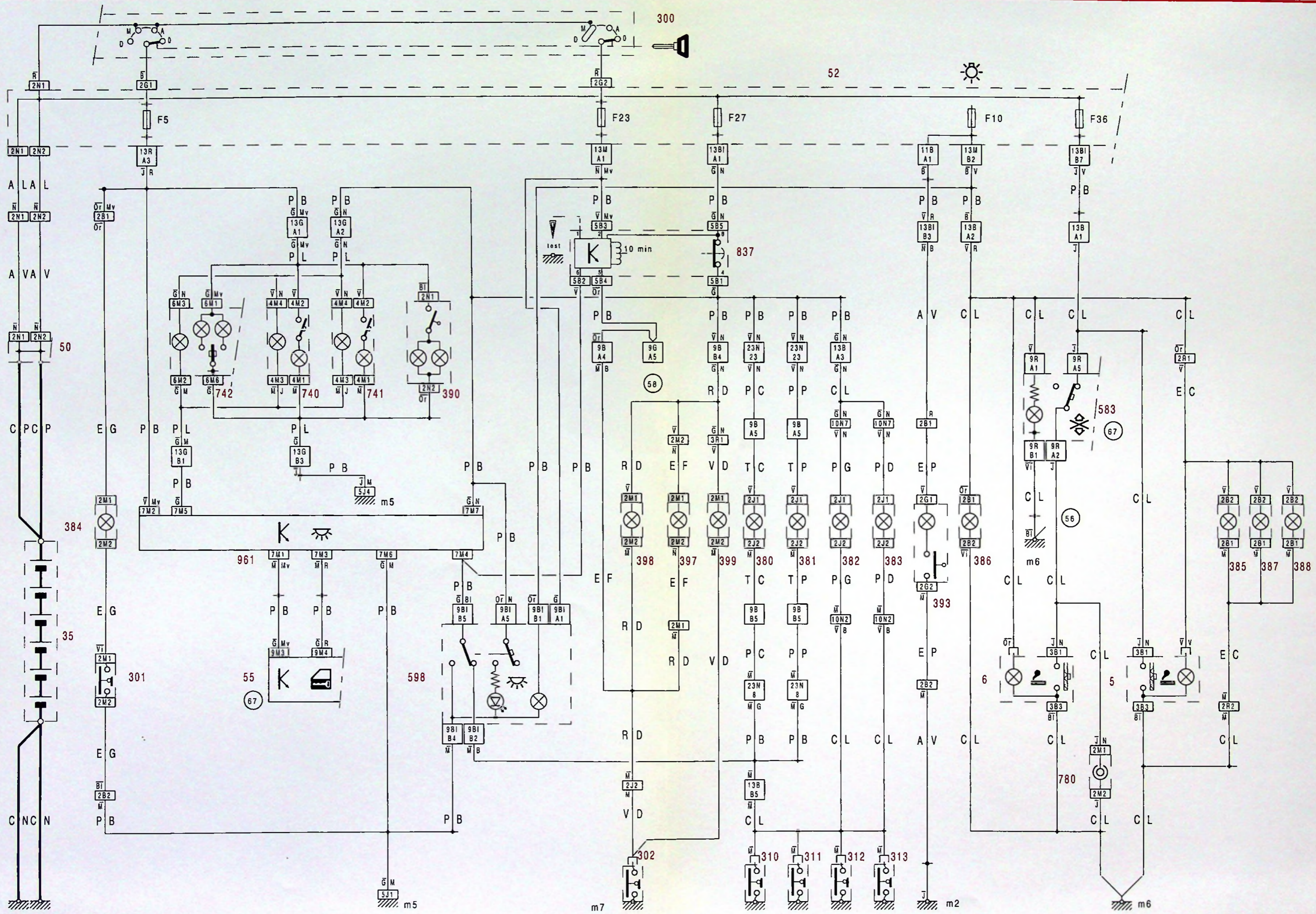

550-0/20

1 2 3 4 5 6 7 8 9 10 11 12 13 14 15 16 17 18 19 20 21 22 23 24 25 26 27 28 29 30 31 32 33 34 35 36 37 38 39 40 41 42 43 44 45 46 47 48 49 50 51 52 53 54 55 56 57 58 59 60 61 62

550-0/20