



64



XM
640-000/1

1

FONCTION : CLIMATISATION

LISTE DES SCHEMAS



AERATION - CHAUFFAGE

NUMERO	DIRECTION	VALIDITE	DESIGNATION
641-00/10	Gauche	05/89 → → 07/93	XM 4 CYL ESSENCE, 6 CYL, DIESEL ATMOSPHERIQUE Evolution a : affectations relais, modification masses faisceau PB.
641-00/10a	Gauche	07/93 →	
641-00/11	Gauche	10/92 → → 07/93	XM TURBO DIESEL Evolution a : affectations relais, modification masses faisceau PB.
641-00/11a	Gauche	07/93 →	
641-00/12	Gauche	10/92 → → 07/93	XM TURBO ESSENCE Evolution a : affectations relais, modification masses faisceau PB
641-00/12a	Gauche	07/93 →	
641-2/10	Droite	01/90 → → 12/92	XM CARBU GB (ANTI-PERCOLATION)

CHAUFFAGE REGULE

NUMERO	DIRECTION	VALIDITE	DESIGNATION
642-00/10	Gauche	11/89 → → 10/92	XM TURBO DIESEL Evolution a : Modification interconnexions entre faisceaux PB, AV, MT. Evolution b : Affectations relais, modification masses faisceau PB.
642-00/10a	Gauche	10/92 → → 07/93	
642-00/10b	Gauche	07/93 →	
642-00/11	Gauche	05/89 → → 10/92	XM 4 CYL ESSENCE, 6 CYL, DIESEL ATMOSPHERIQUE Evolution a : Modification interconnexions entre faisceaux PB, AV, MT. Evolution b : Affectations relais, modification masses faisceau PB.
642-00/11a	Gauche	10/92 → → 07/93	
642-00/11b	Gauche	07/93 →	



64



XM
640-000/1

3

642-00/12	Droite	04/90 → → 10/92	XM 4 CYL ESSENCE, 6 CYL, DIESEL ATMOSPHERIQUE Evolution a : Modification interconnexions entre faisceaux PB, AV, MT. Evolution b : affectations relais, modification masses faisceau PB.
642-00/12a	Droite	10/92 → → 07/93	
642-00/12b	Droite	07/93 →	
642-00/13	Gauche	10/92 → → 07/93	XM TURBO ESSENCE BVA Evolution a : affectations relais, modification masses faisceau PB.
642-00/13a	Gauche	07/93 →	

REFRI SEMI-AUTO

NUMERO	DIRECTION	VALIDITE	DESIGNATION
643-00/10	Gauche	05/89 →	XM TT Sauf 6 CYL Evolution a : Modif. câblage moteur mixage d'air Evolution b : Branchement du boîtier de T° d'eau pour le post-refroidissement.
643-00/10a	Gauche	→ 03/92	
643-00/10b	Gauche	03/92 → → 10/92	
643-00/11	Gauche	11/89 → → 03/92	XM 6 CYL Sauf 24 S Evolution a : Branchement du boîtier de T° d'eau pour le post-refroidissement.
643-00/11a	Gauche	03/92 → → 10/92	
643-00/12	Droite	05/90 → → 03/92	XM 6 CYL Sauf 24 S Evolution a : Branchement du boîtier de T° d'eau pour le post-refroidissement.
643-00/12a	Droite	03/92 → → 10/92	
643-00/13	Gauche	10/92 → → 07/93	XM TOUS TYPES Sauf 24 S Evolution a : affectations relais, modification masses faisceau PB.
643-00/13a	Gauche	07/93 →	
643-2/13	Droite	10/92 → → 07/93	XM TOUS TYPES Sauf 24 S Evolution a : affectations relais, modification masses faisceau PB.
643-2/13a	Droite	07/93 →	



REFRI TOUT-AUTOMATIQUE

NUMERO	DIRECTION	VALIDITE	DESIGNATION
644-00/10	Gauche	07/90 → → 02/91	XM 6 CYL 24 S Evolution calculateur inj. (indice K) Evolution b : Branchement du boîtier de T° d'eau pour le post-refroidissement.
644-00/10a	Gauche	02/91 → → 03/92	
644-00/10b	Gauche	03/92 → → 10/92	
644-00/11	Gauche	07/90 → → 03/92	XM 6 CYL Sauf 24 S Evolution a : Branchement du boîtier de T° d'eau pour le post-refroidissement.
644-00/11a	Gauche	03/92 → → 10/92	
644-00/12	Droite	07/90 → → 03/92	XM 6 CYL Sauf 24 S Evolution a : Branchement du boîtier de T° d'eau pour le post-refroidissement.
644-00/12a	Droite	03/92 → → 10/92	
644-00/13	Gauche	07/90 → → 03/92	XM TURBO DIESEL Evolution a : Branchement du boîtier de T° d'eau pour le post-refroidissement.
644-00/13a	Gauche	03/92 → → 10/92	
644-00/14	Gauche	07/90 → → 03/92	XM 4 CYL Inj Multipoint Evolution a : Branchement du boîtier de T° d'eau pour le post-refroidissement.
644-00/14a	Gauche	03/92 → → 10/92	
644-00/15	Gauche	10/92 → → 07/93	XM TOUS TYPES Evolution a : affectation relais, modification masses faisceau PB.
644-00/15a	Gauche	07/93 →	
644-2/15	Droite	10/92 → → 07/93	XM TOUS TYPES Evolution a : affectation relais, modification masses faisceau PB.
644-2/15a	Droite	07/93 →	

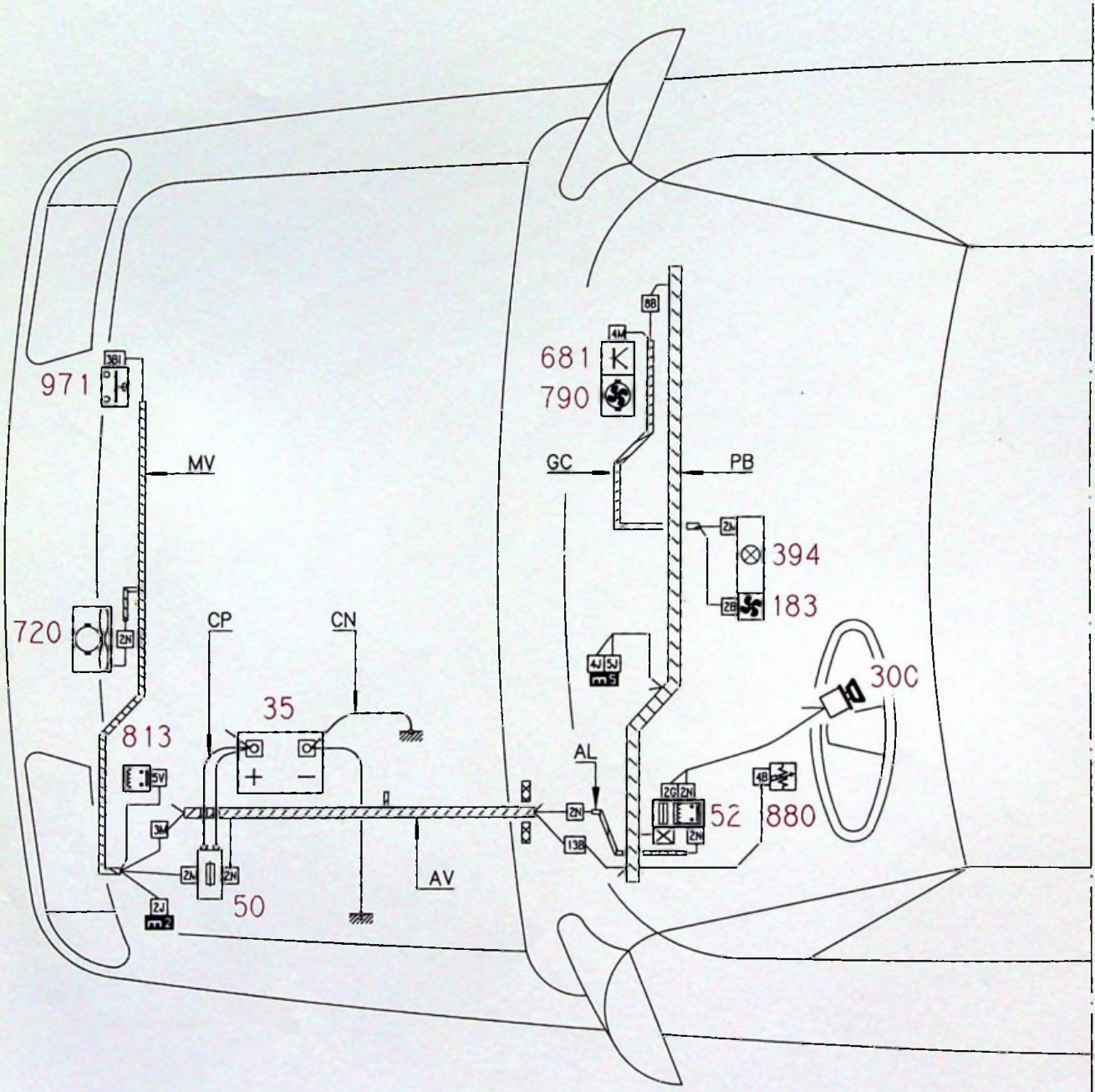



64



XM
641-00/10

3

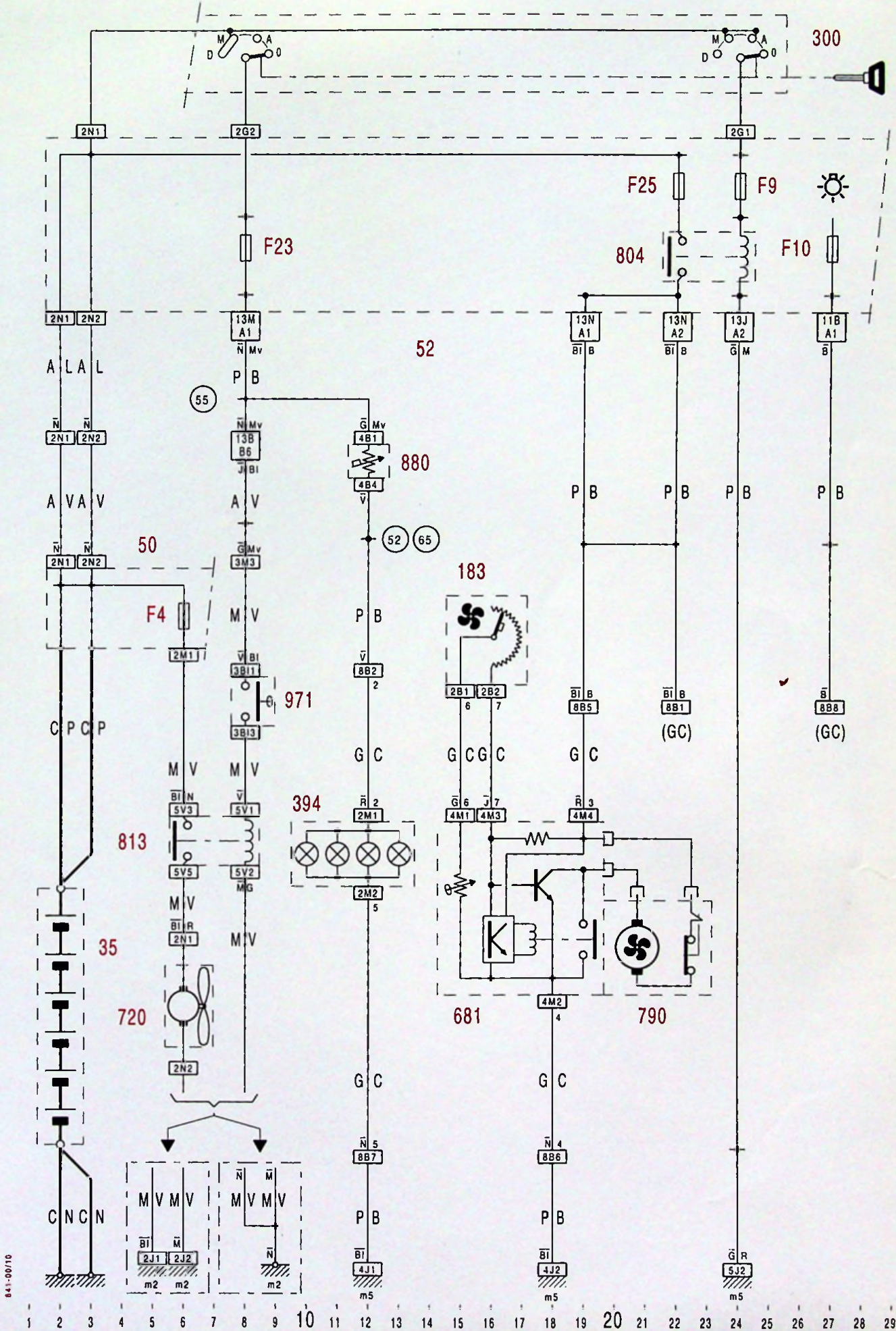



64



XM
641-00/10a

5

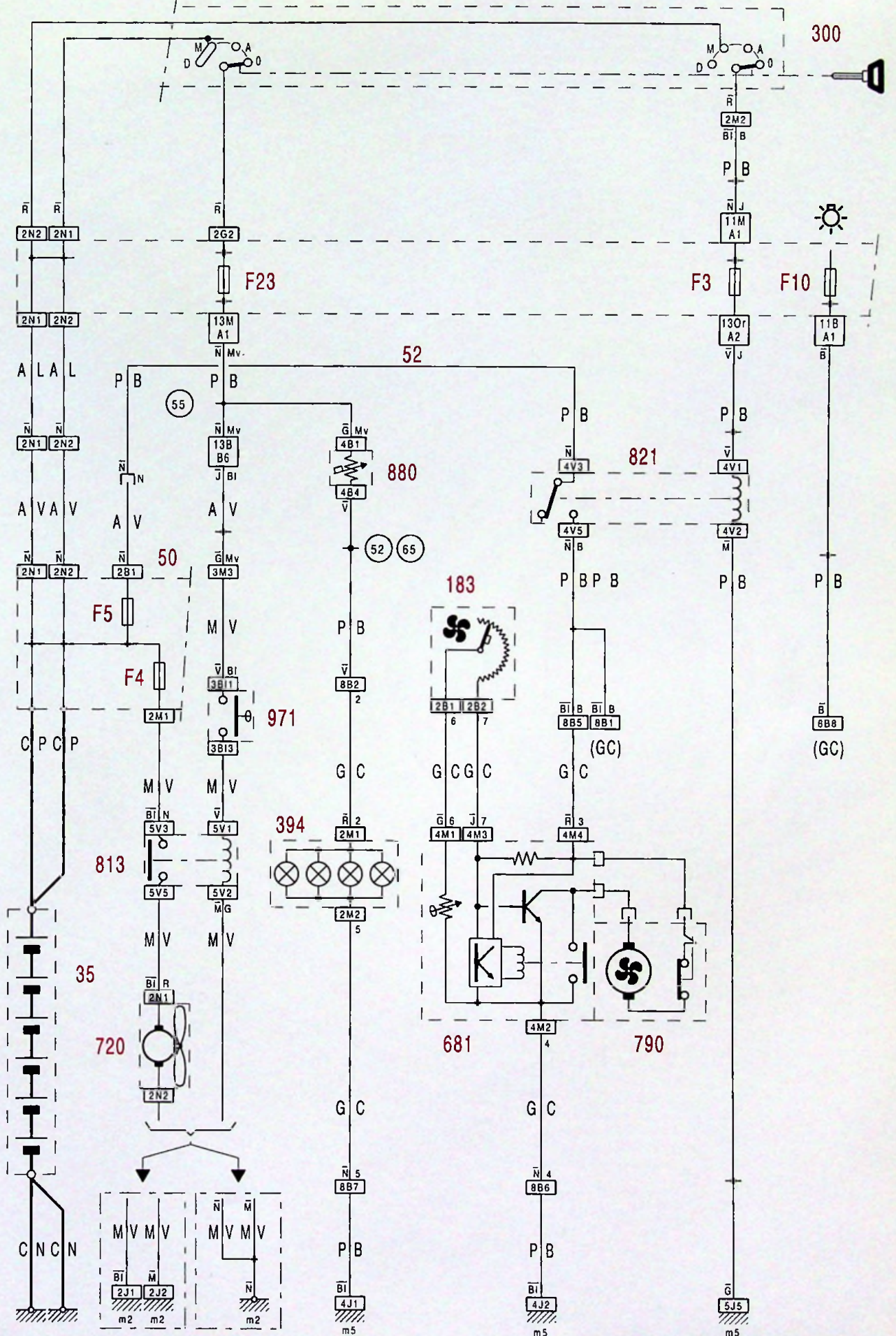

641-00/10a

641-00/10a



64



XM
641-00/11

3

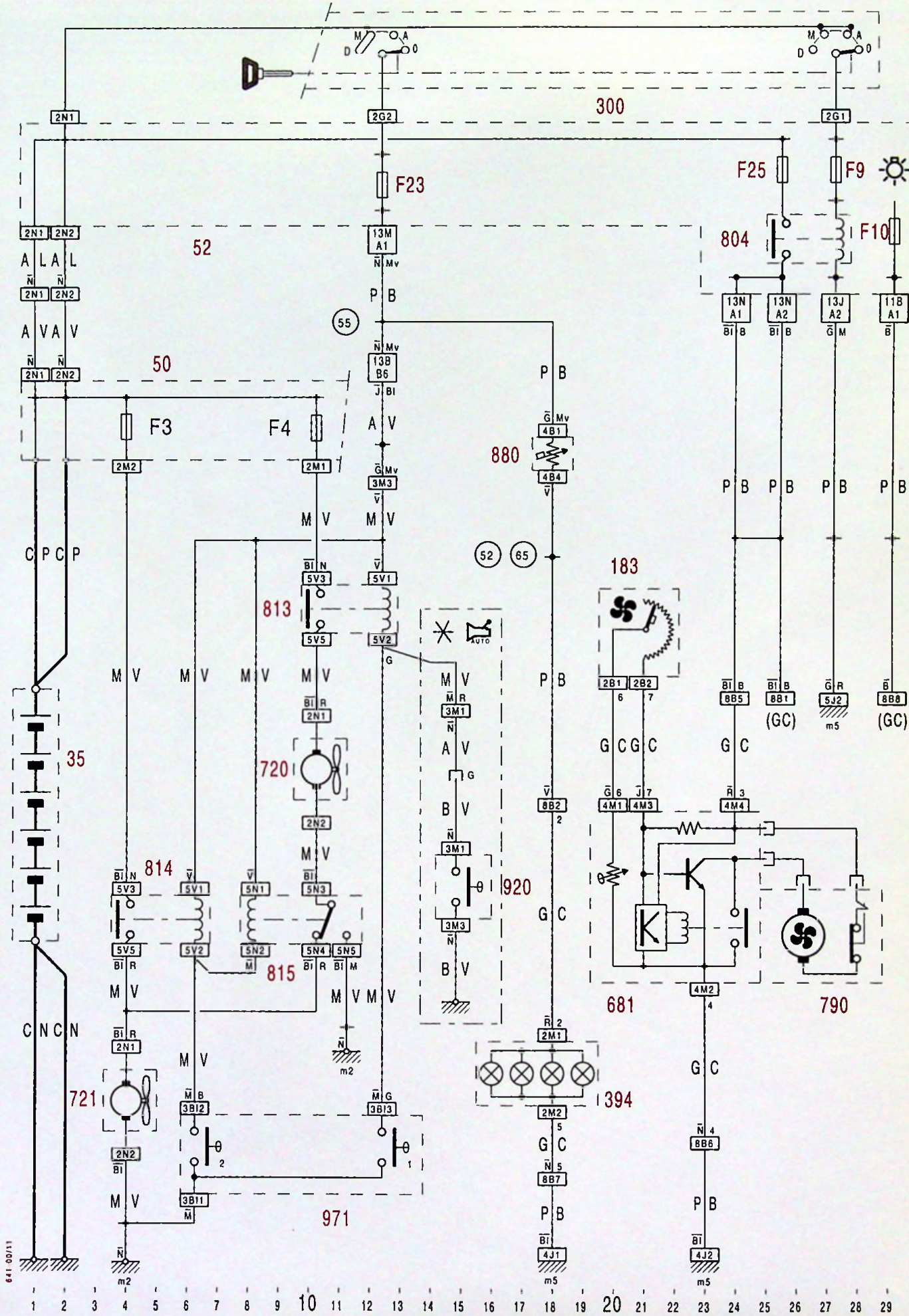



64



XM
641-00/11a

5

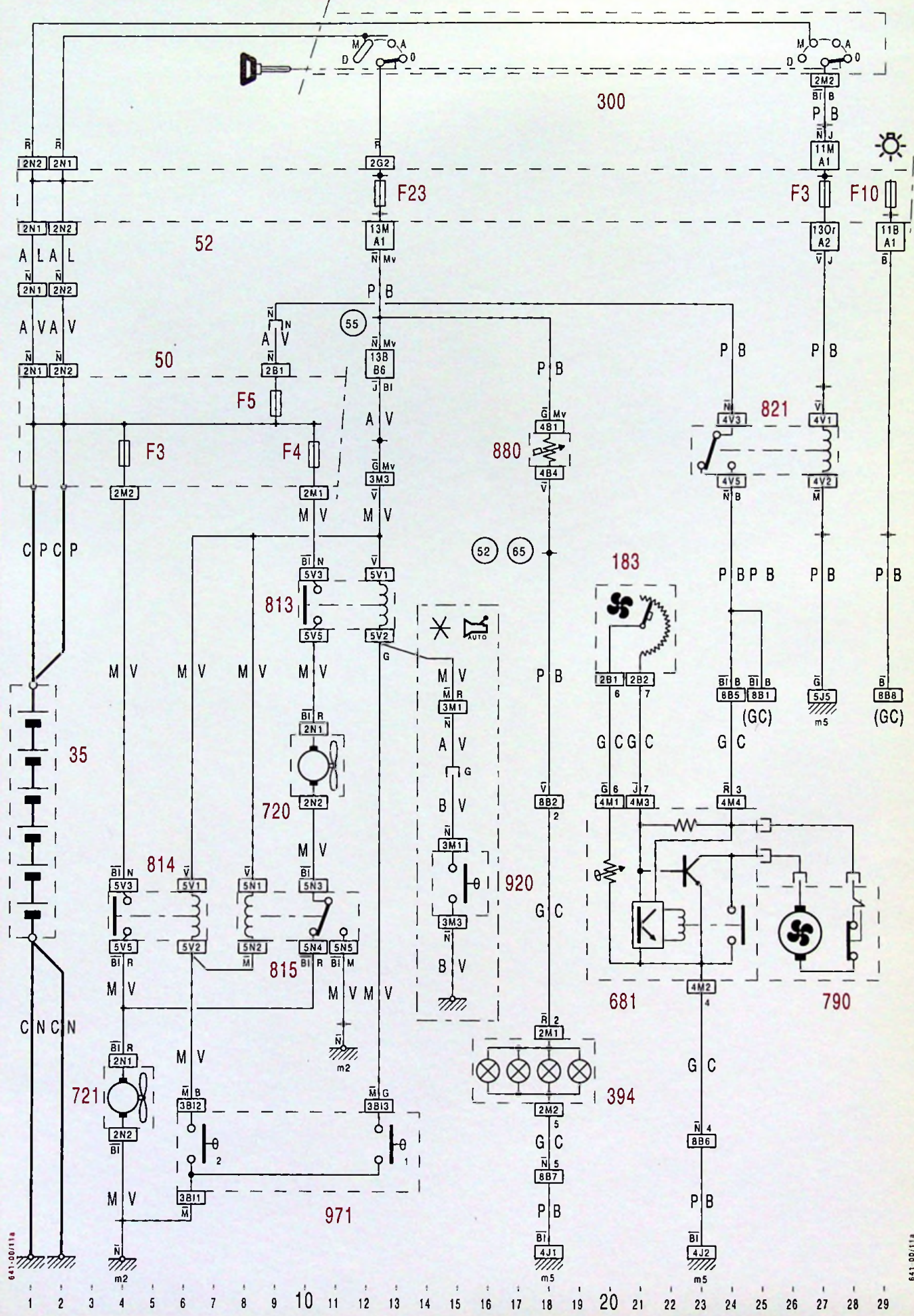



64



XM
641-00/12

4

5

XM
641-00/12



64

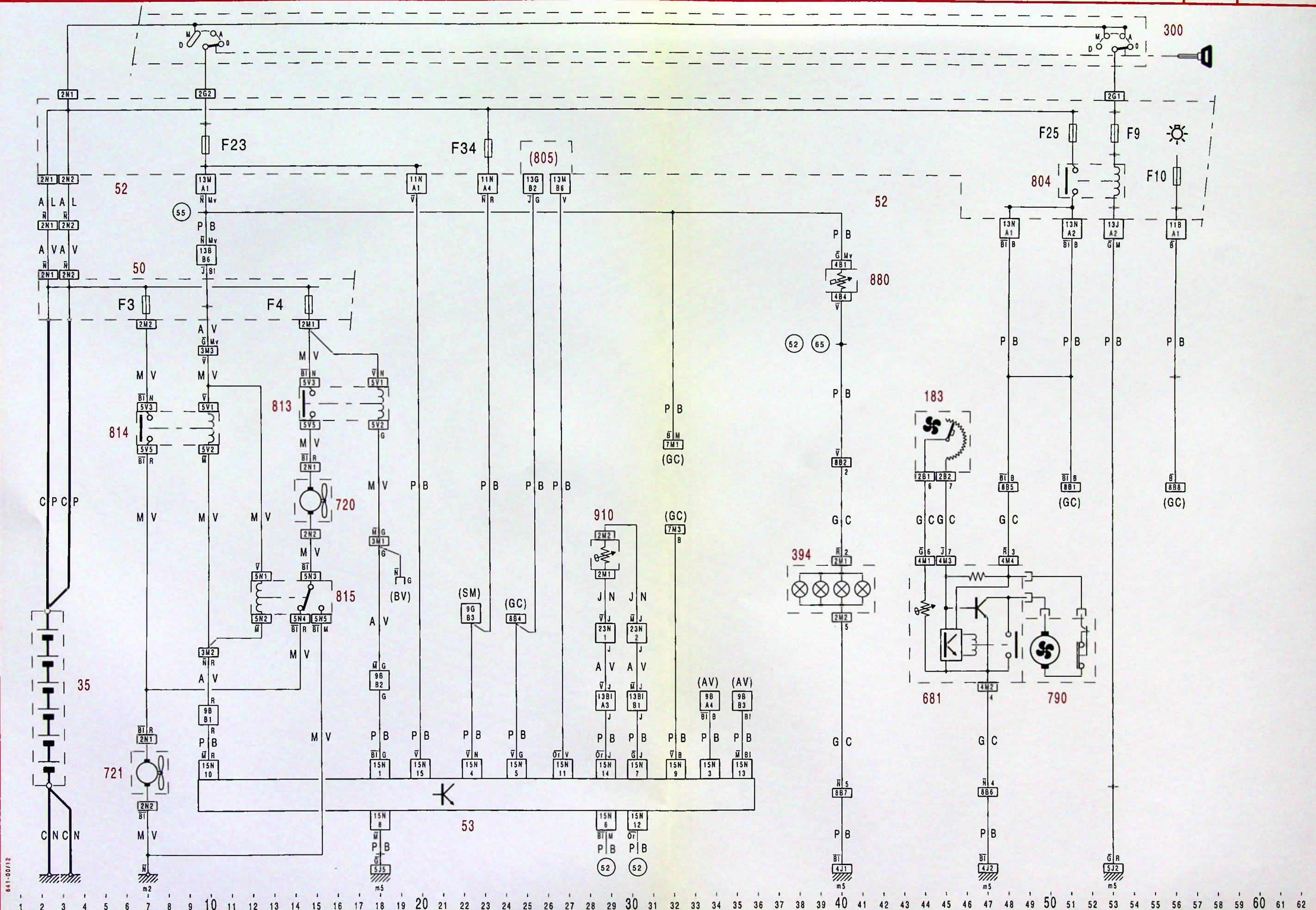

641-00/12

641-00/12



64



XM
641-00/12a

6

7

XM
641-00/12a

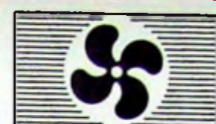

64

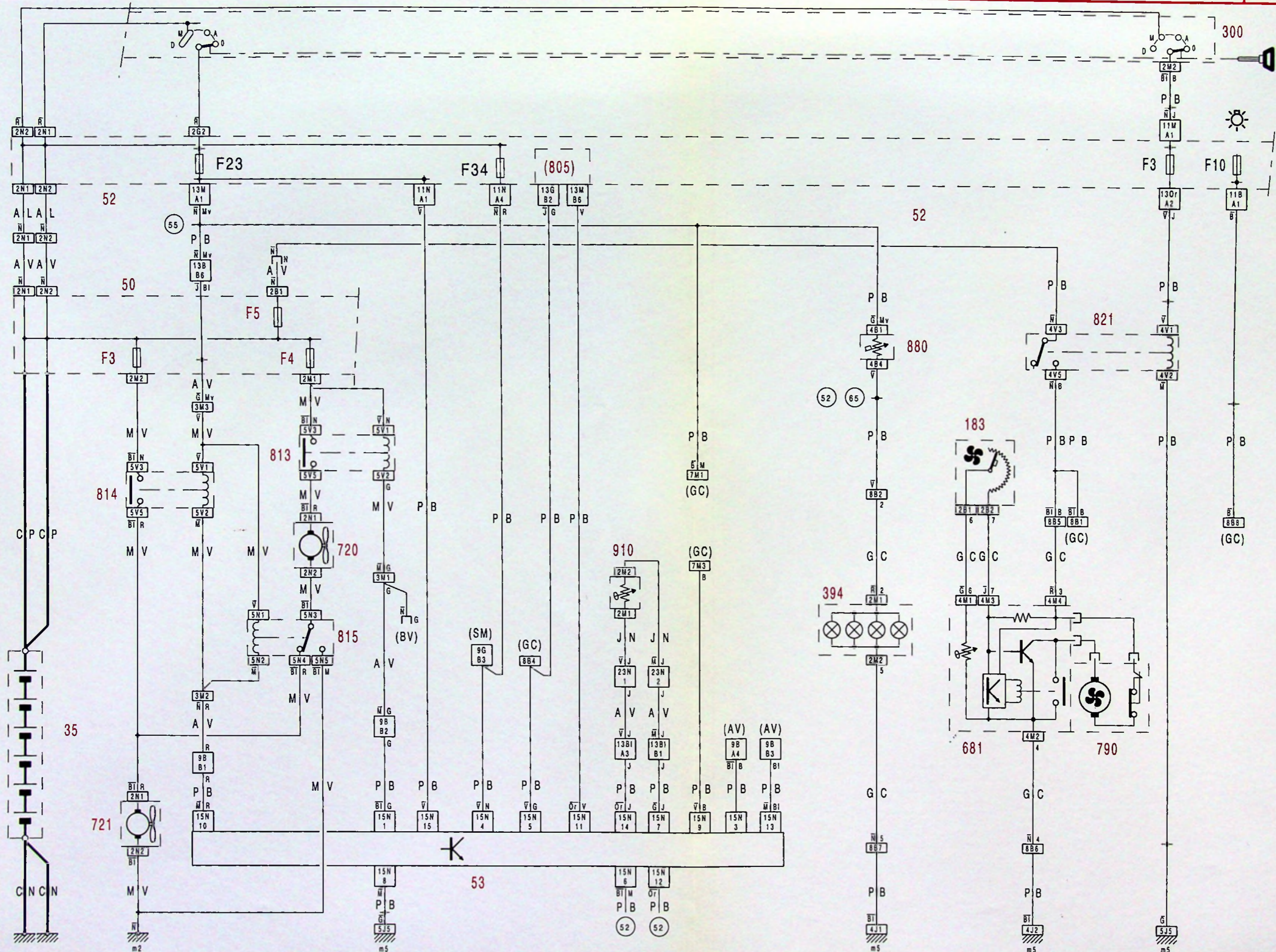

641-00/12a

641-00/12a

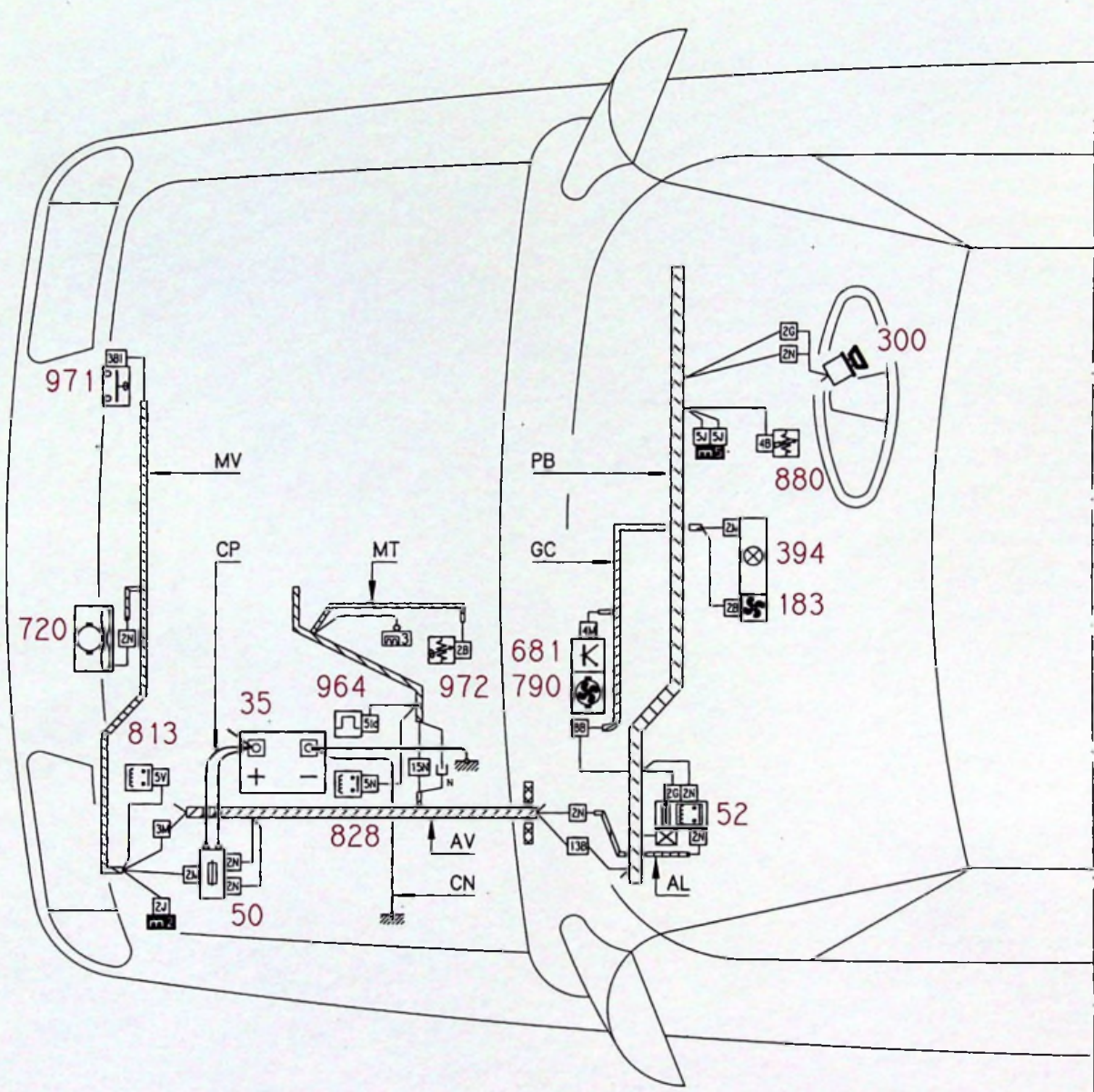



64



XM
641-2/10

3

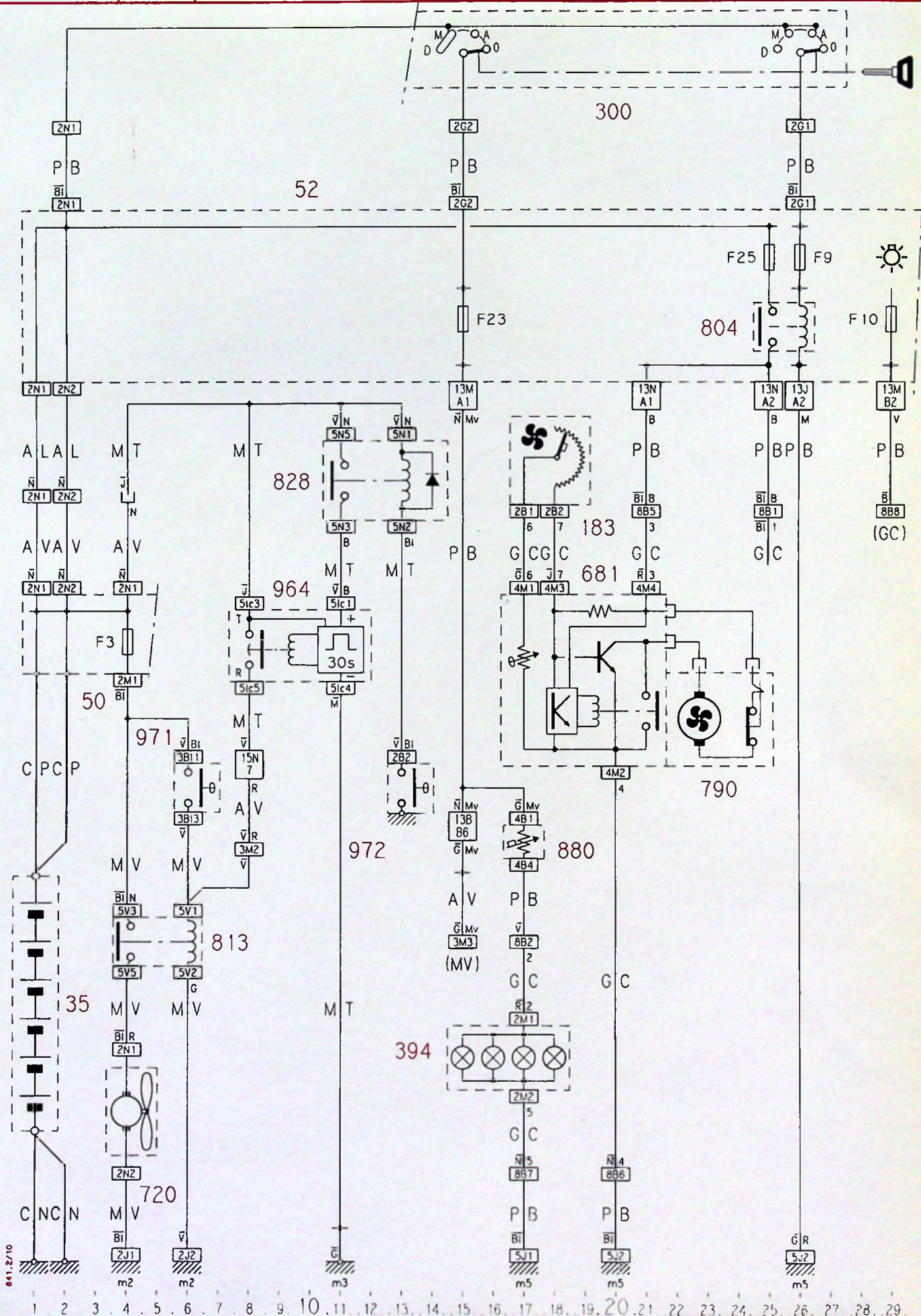

641.2/10

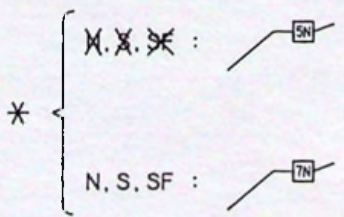
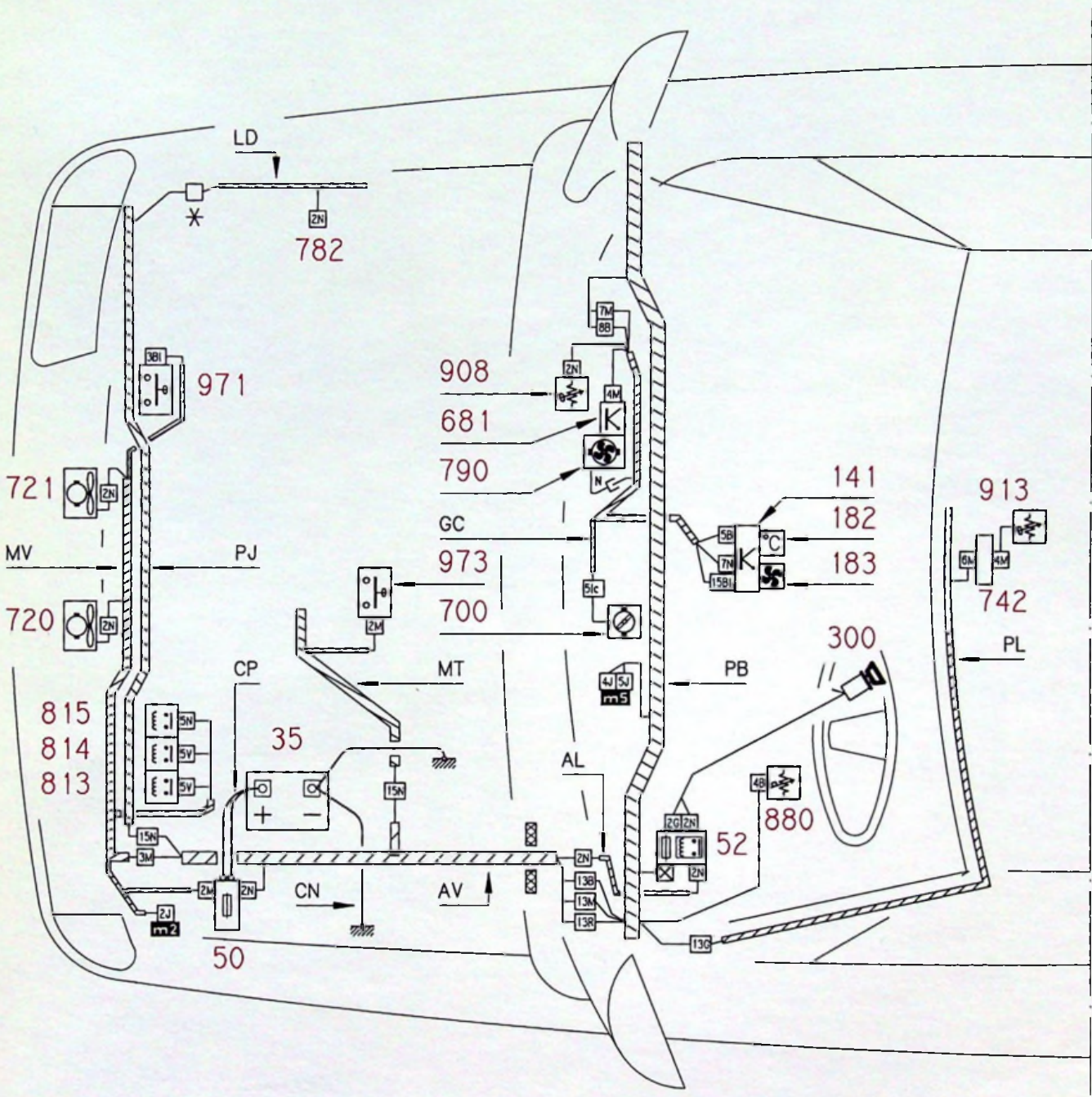



64



XM
642-00/10

4

5

XM
642-00/10



64

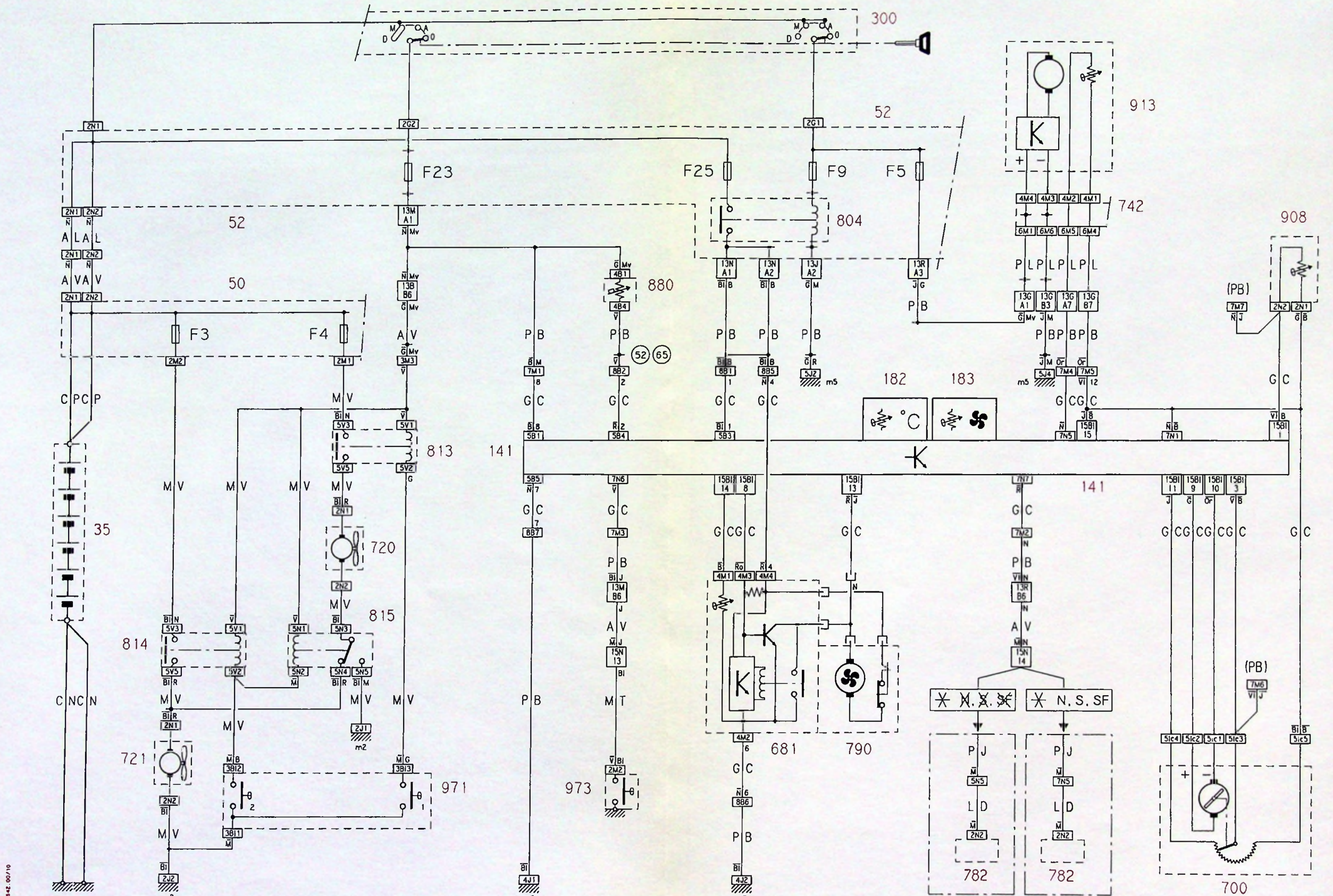

642-00/10

1 2 3 4 5 6 7 8 9 10 11 12 13 14 15 16 17 18 19 20 21 22 23 24 25 26 27 28 29 30 31 32 33 34 35 36 37 38 39 40 41 42 43 44 45 46 47 48 49 50 51 52 53 54 55 56 57 58 59 60 61 62



64



XM
642-00/10a

4

5

XM
642-00/10a



64

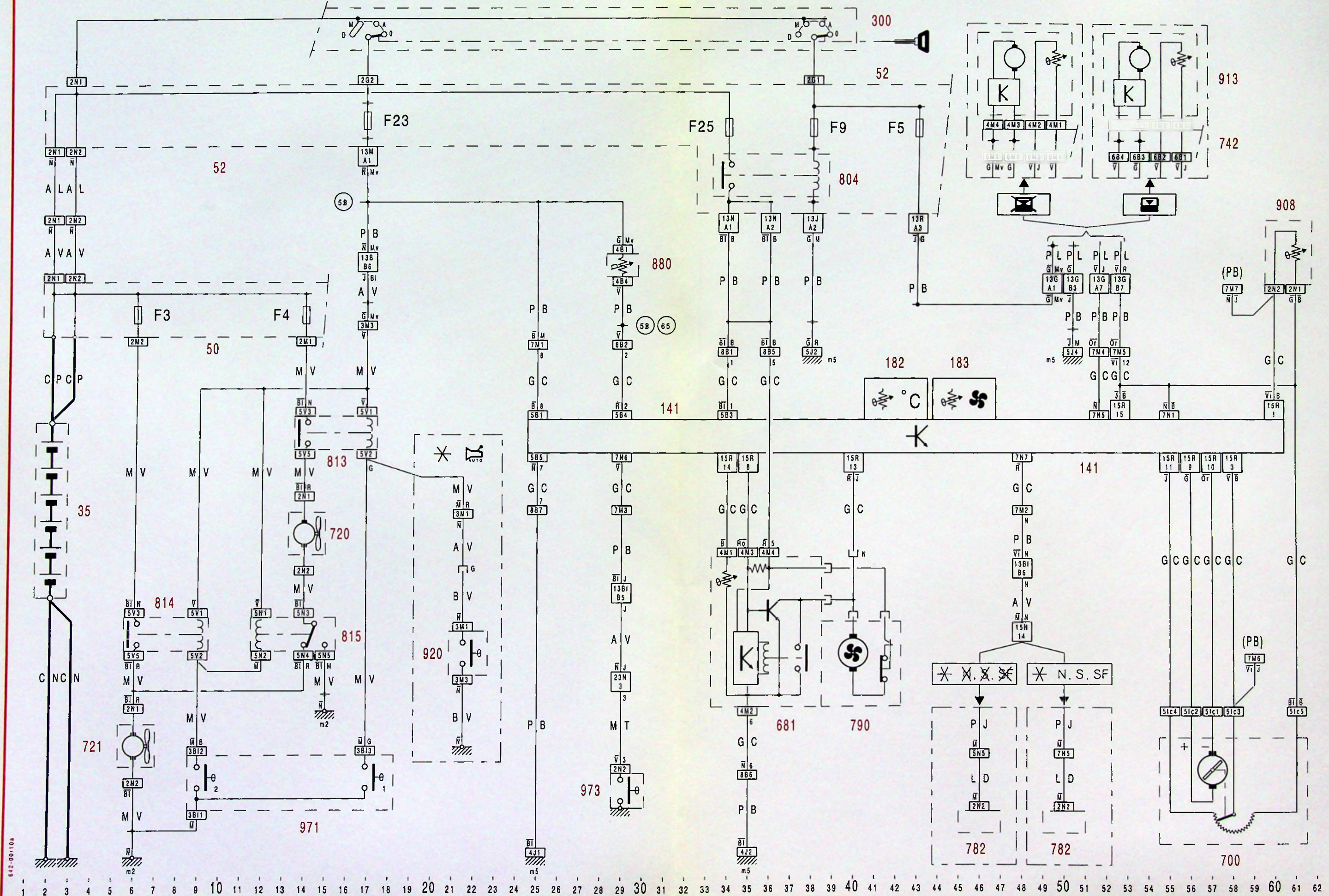

642-00/10a

642-00/10a



64



XM
642-00/10b

6

7

XM
642-00/10b



64

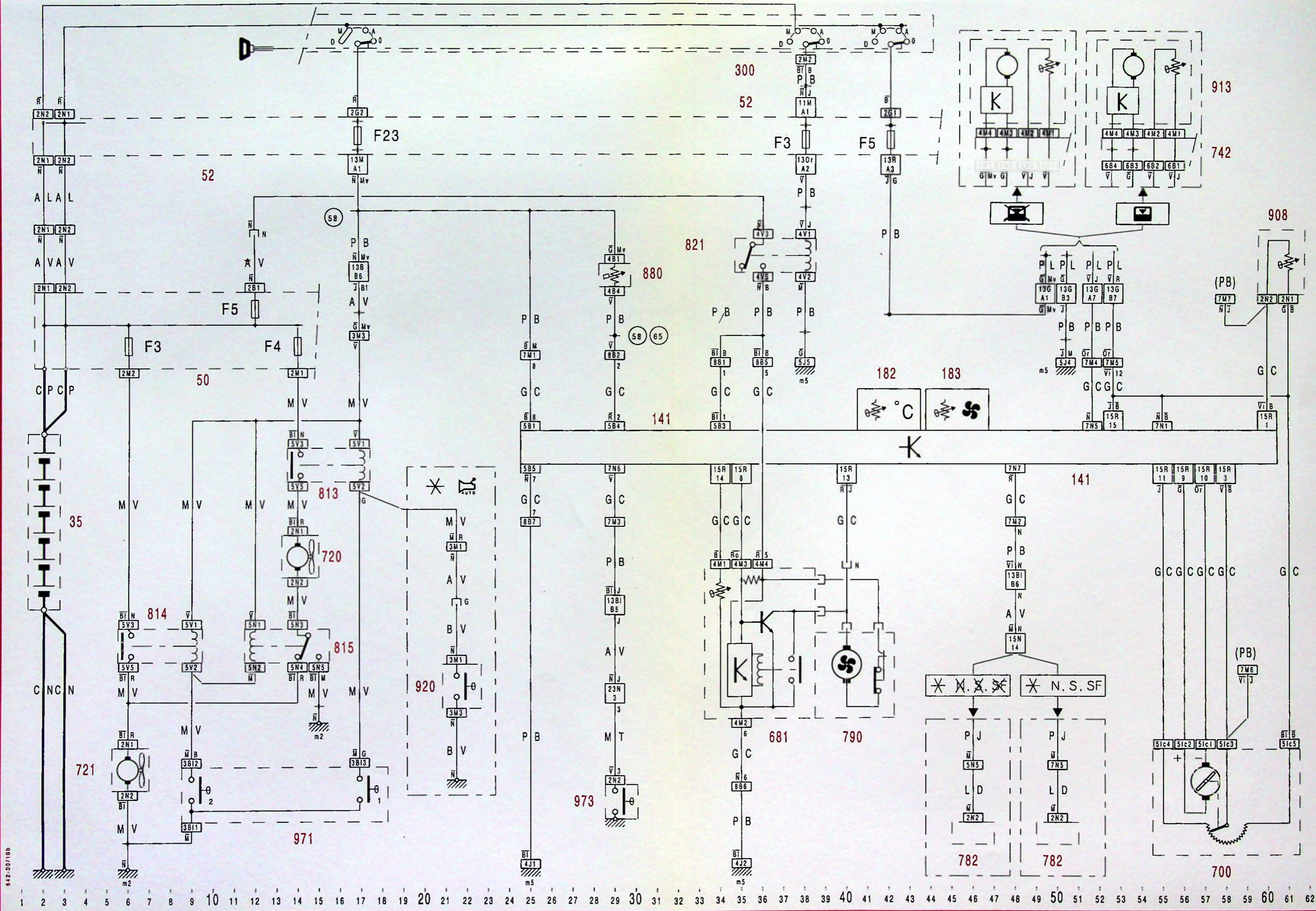

642-00/10b

642-00/10b

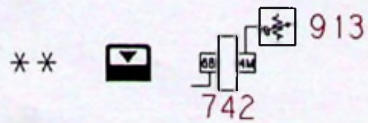
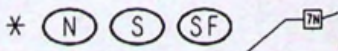
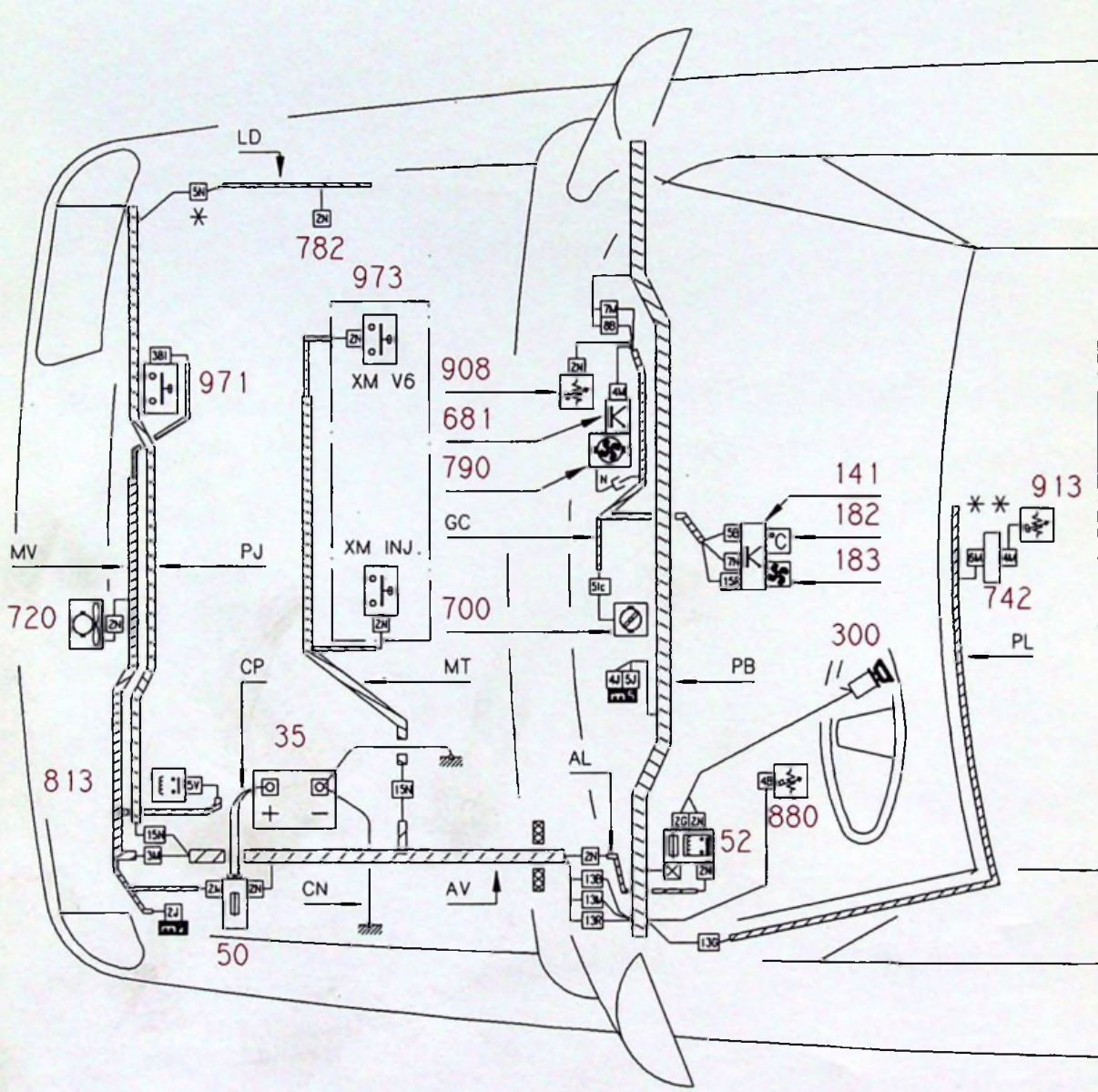



64



XM
642-00/11

4

5

XM
642-00/11



64

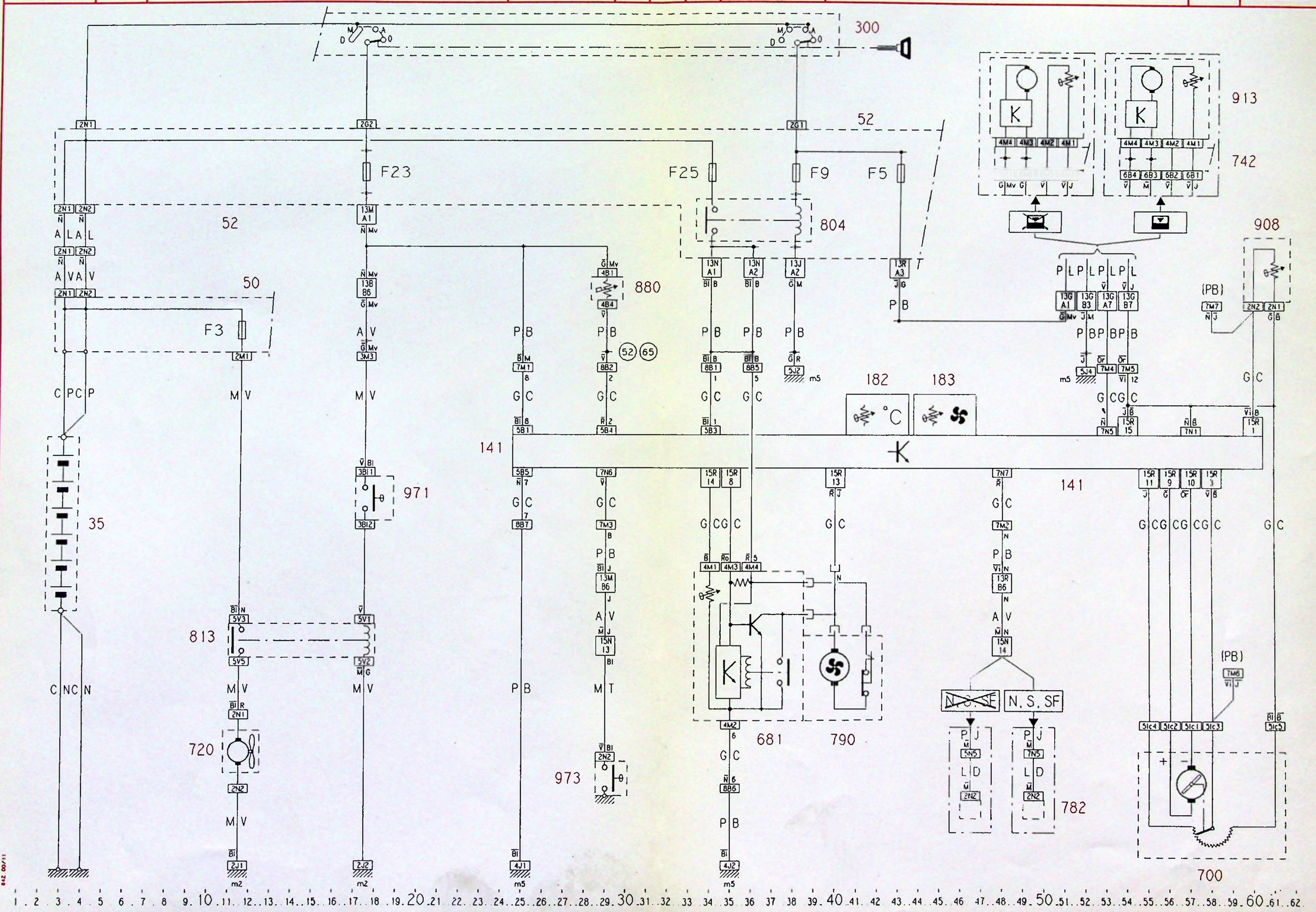

642 00/11

1 . 2 . 3 . 4 . 5 . 6 . 7 . 8 . 9 . 10 . 11 . 12 . 13 . 14 . 15 . 16 . 17 . 18 . 19 . 20 . 21 . 22 . 23 . 24 . 25 . 26 . 27 . 28 . 29 . 30 . 31 . 32 . 33 . 34 . 35 . 36 . 37 . 38 . 39 . 40 . 41 . 42 . 43 . 44 . 45 . 46 . 47 . 48 . 49 . 50 . 51 . 52 . 53 . 54 . 55 . 56 . 57 . 58 . 59 . 60 . 61 . 62



64



XM
642-00/11a

4

5

XM
642-00/11a

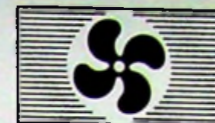

64

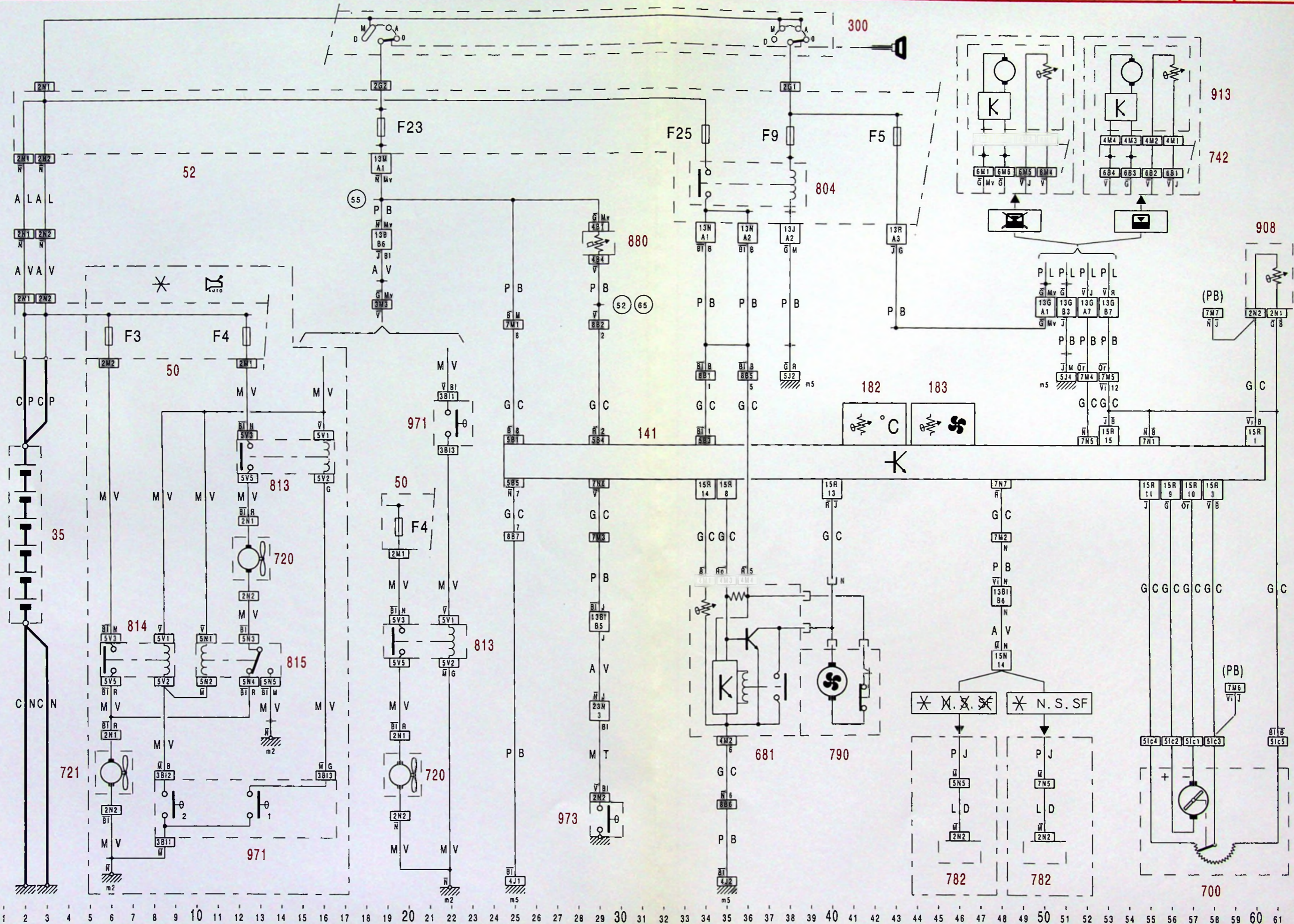

642-00/11a

642-00/11a



64



XM
642-00/11a

4

5

XM
642-00/11a



64

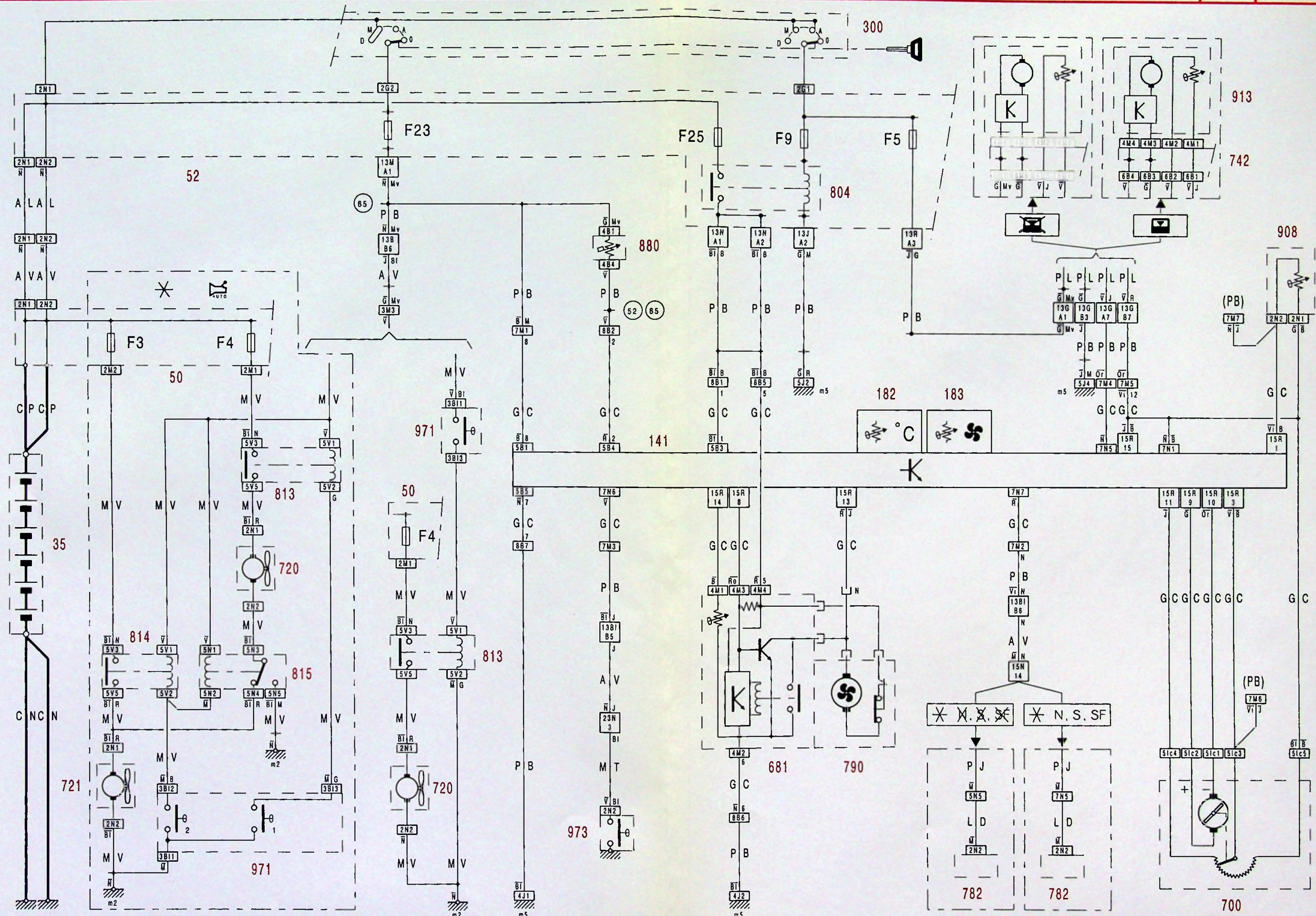

642-00/11a

642-00/11a

1 2 3 4 5 6 7 8 9 10 11 12 13 14 15 16 17 18 19 20 21 22 23 24 25 26 27 28 29 30 31 32 33 34 35 36 37 38 39 40 41 42 43 44 45 46 47 48 49 50 51 52 53 54 55 56 57 58 59 60 61 62



64



XM
642-00/11b

6

7

XM
642-00/11b



64

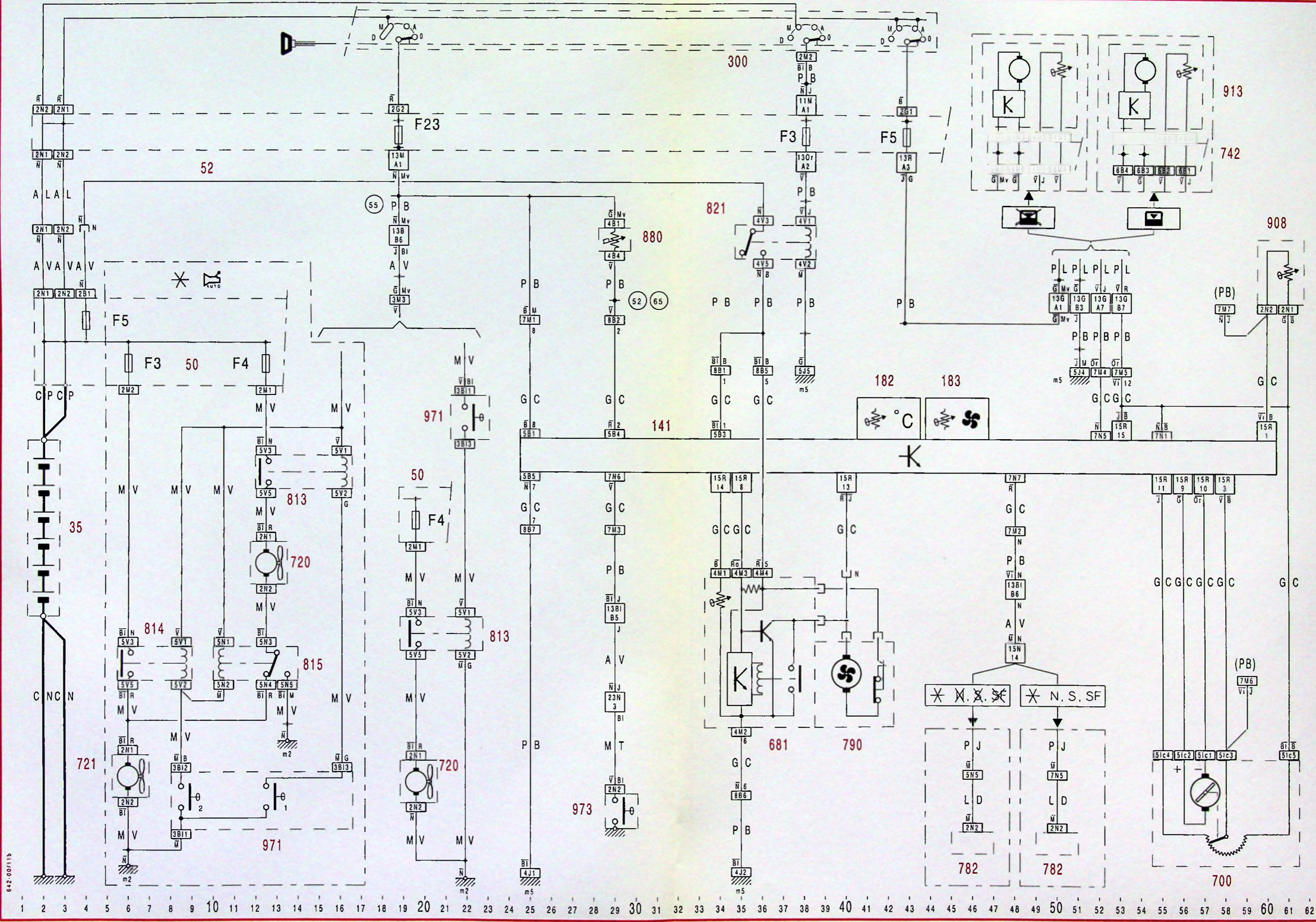

642-00/11b

642-00/11b



64



XM
642-00/12

4

5

XM
642-00/12



64

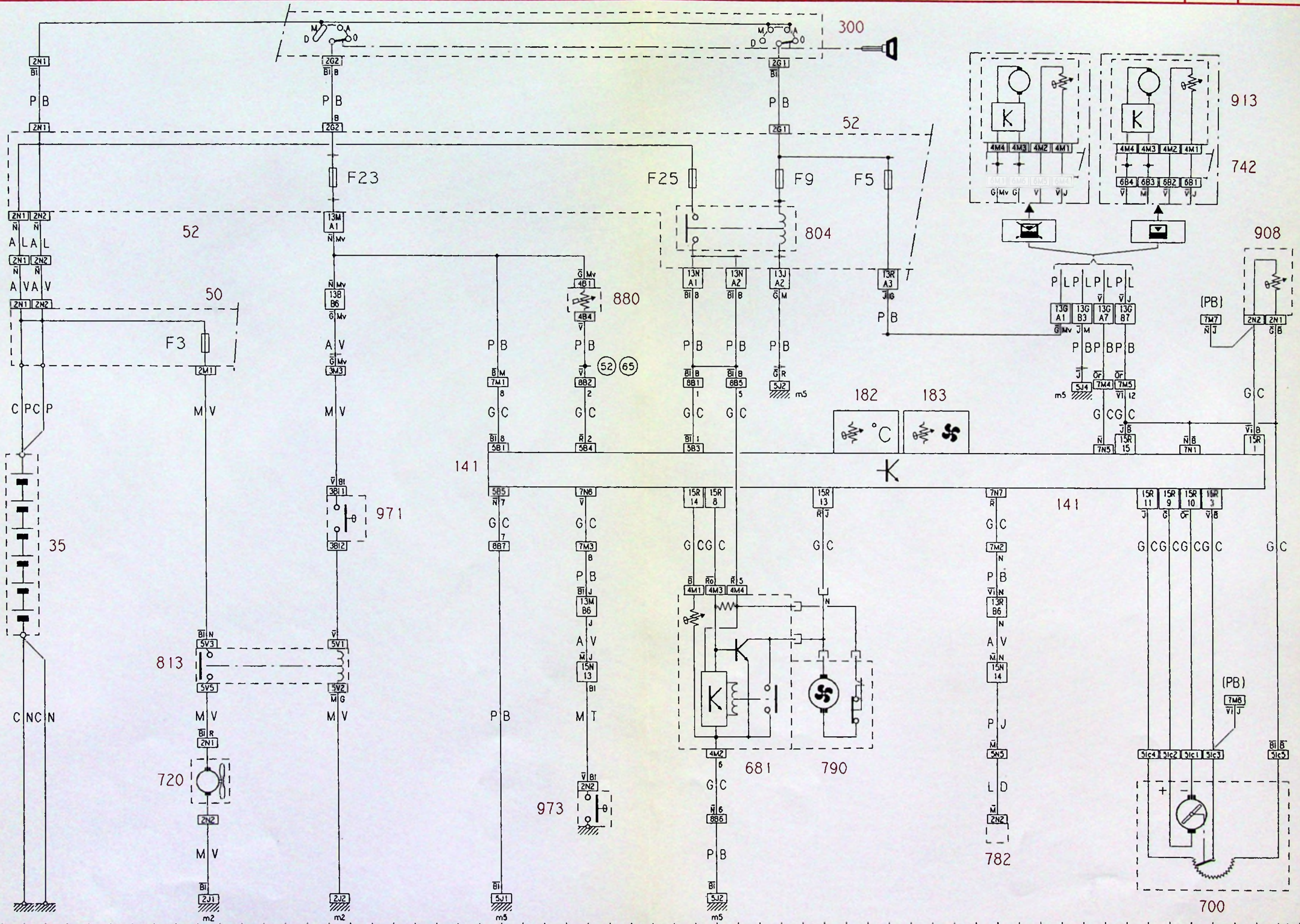

642.00/12

1 2 3 4 5 6 7 8 9 10 11 12 13 14 15 16 17 18 19 20 21 22 23 24 25 26 27 28 29 30 31 32 33 34 35 36 37 38 39 40 41 42 43 44 45 46 47 48 49 50 51 52 53 54 55 56 57 58 59 60 61 62



64



XM
642-00/12a

4

5

XM
642-00/12a

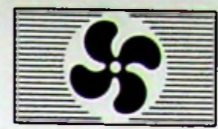

64

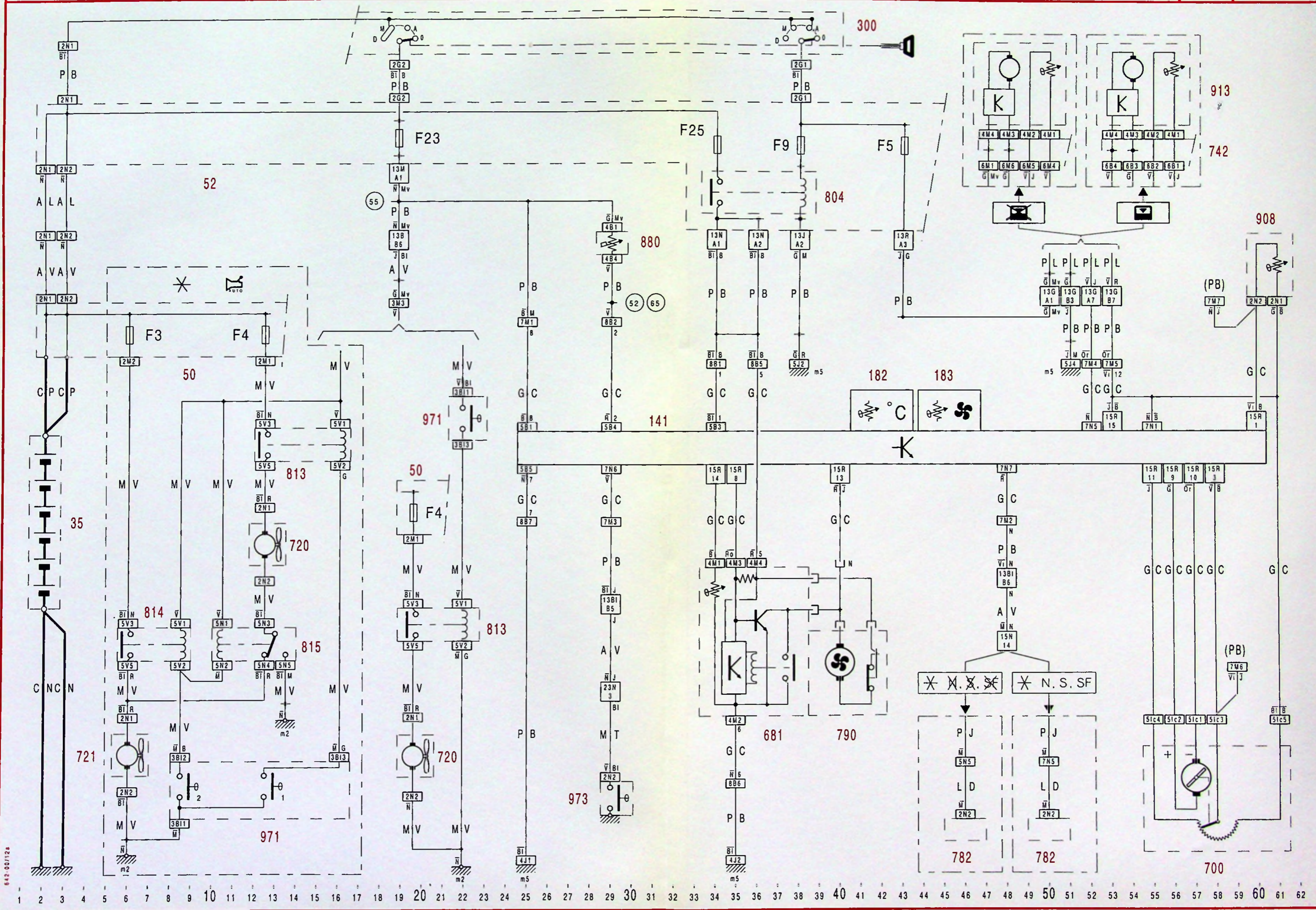

642-00/12a

642-00/12a



64



XM
642-00/12b

6

7

XM
642-00/12b



64

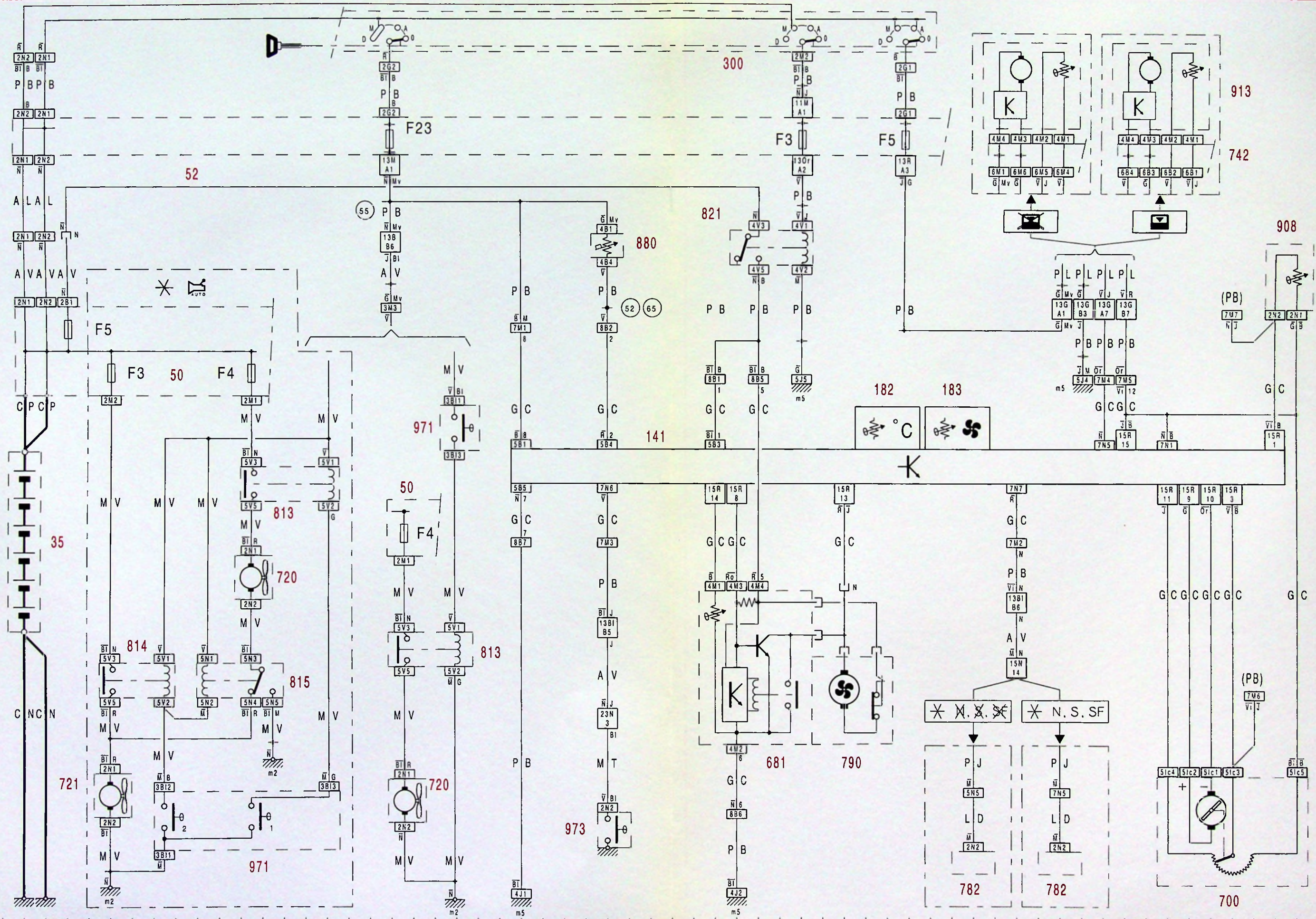

642-00/12b

642-00/12b



64



XM
642-00/13

4

5

XM
642-00/13



64

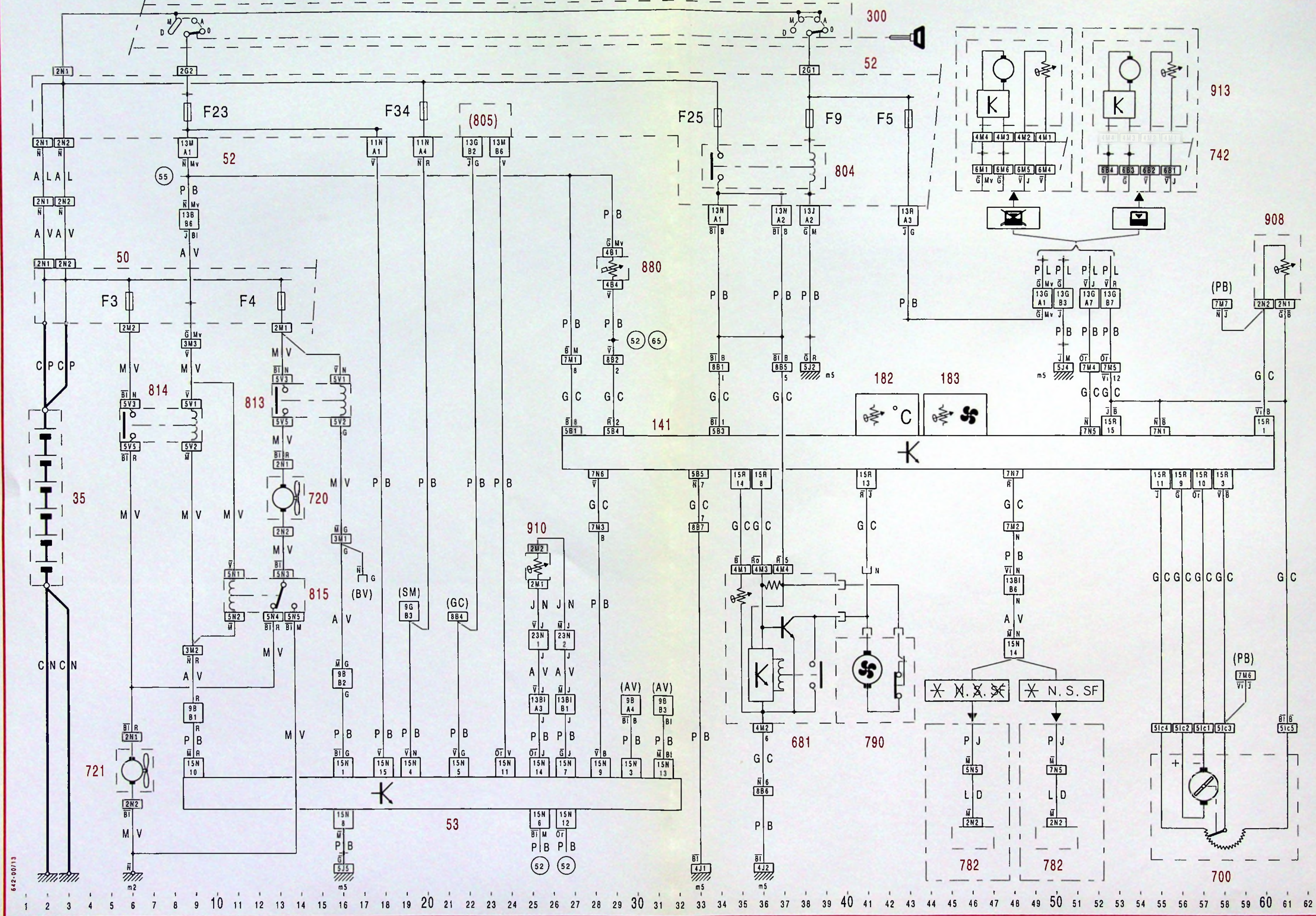

642-00/13

642-00/13



64



XM
642-00/13a

6

7

XM
642-00/13a



64

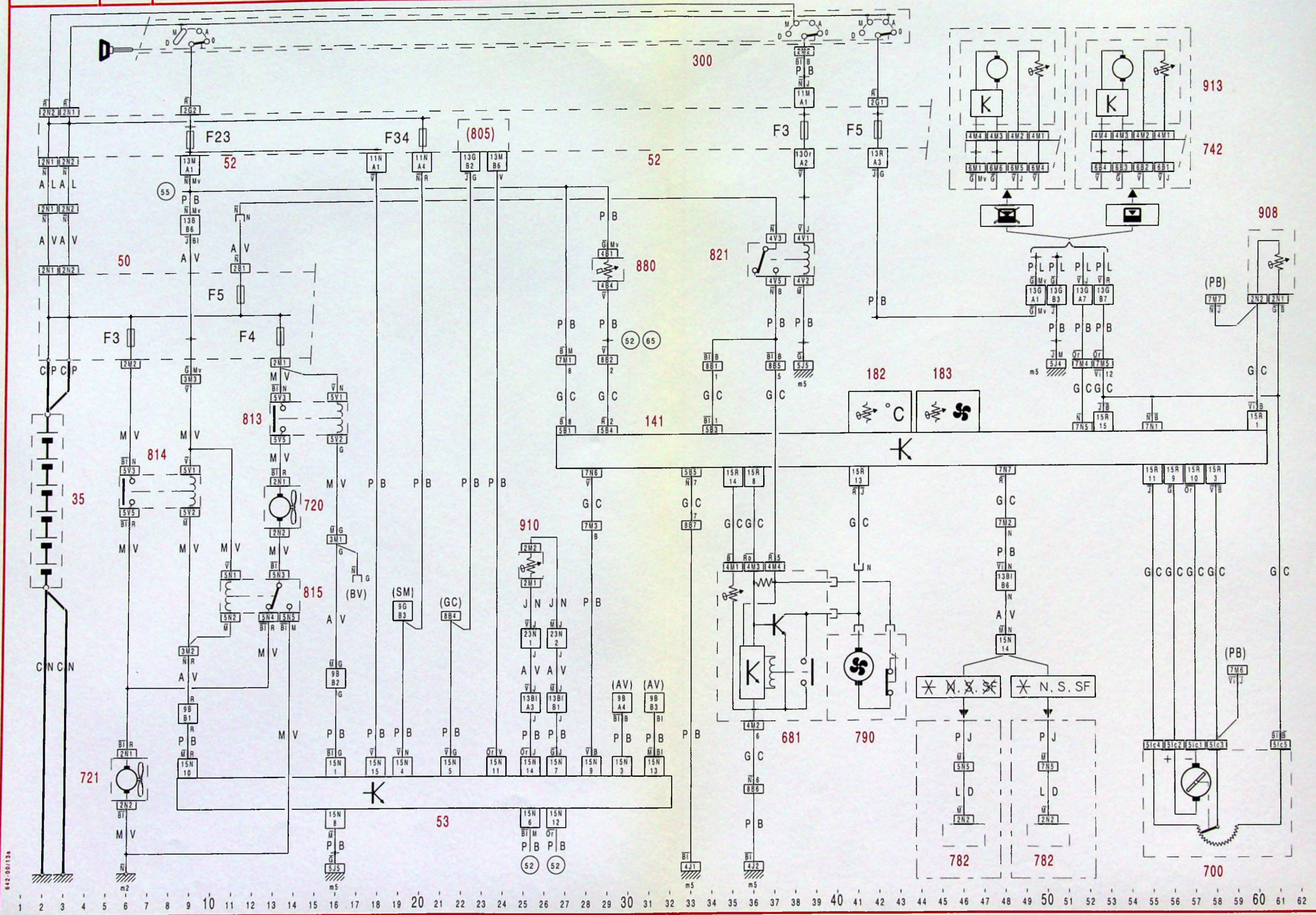

642-00/13a

642-00/13a

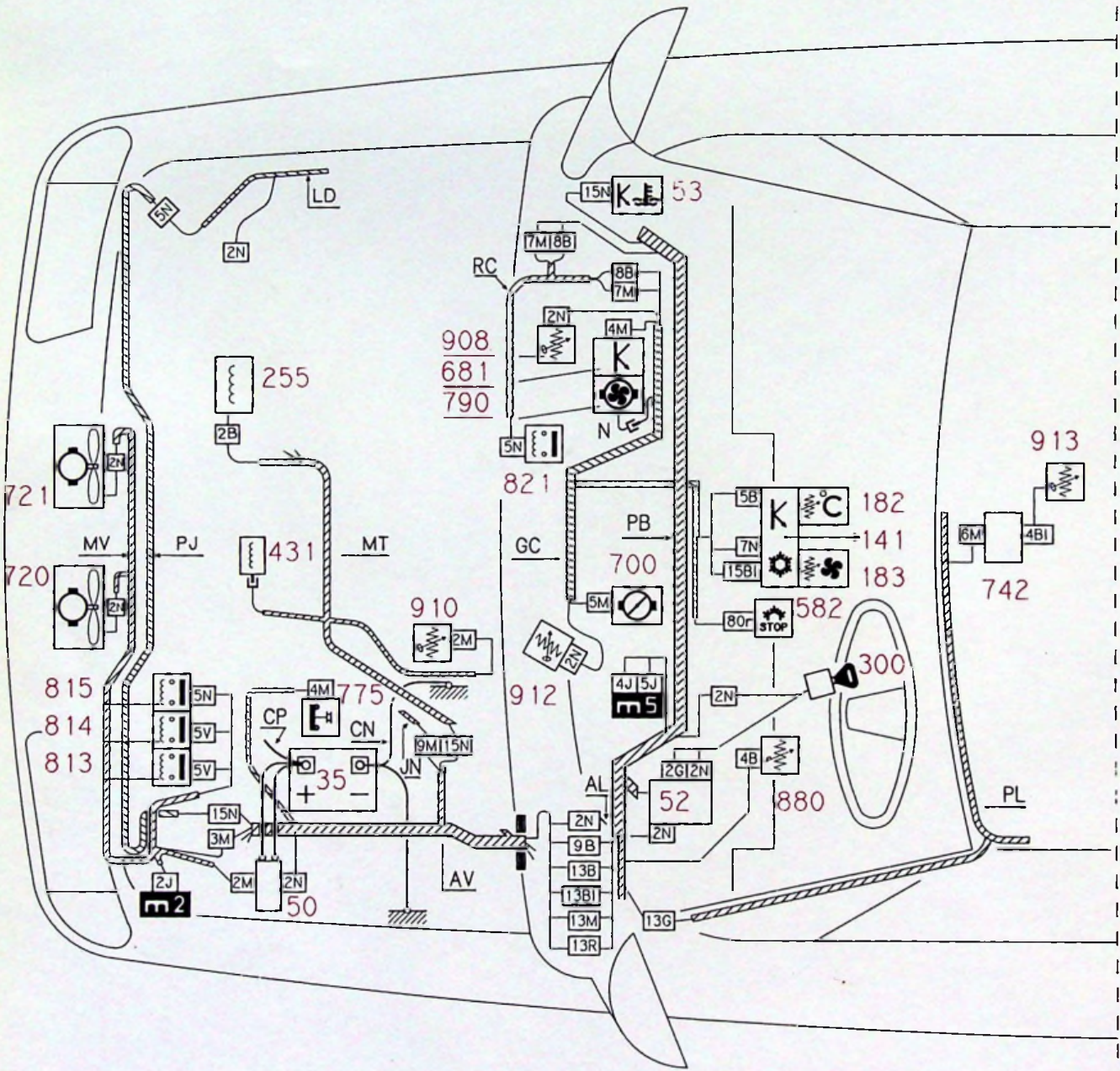



64



XM
643-00/10

4

5

XM
643-00/10



64

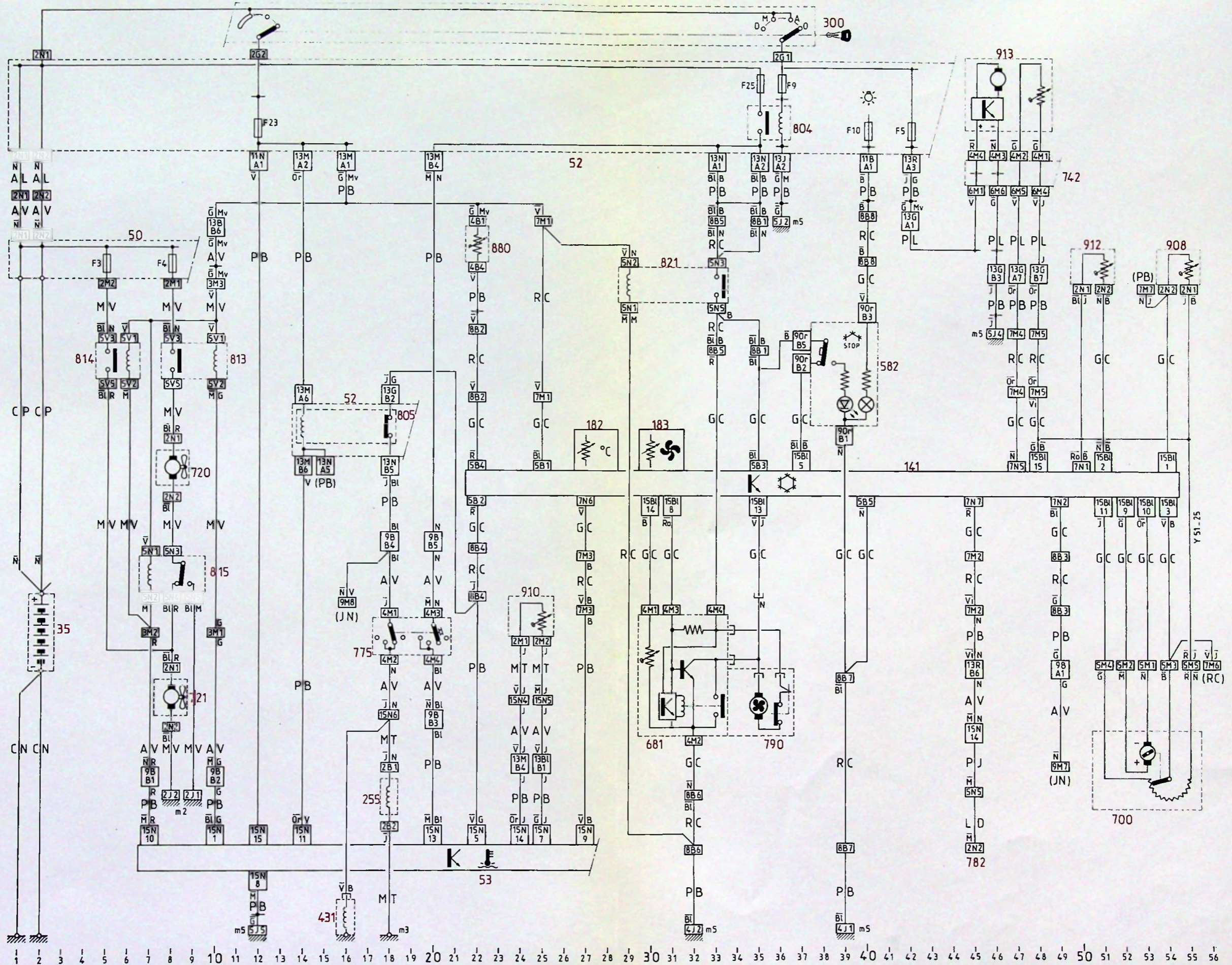

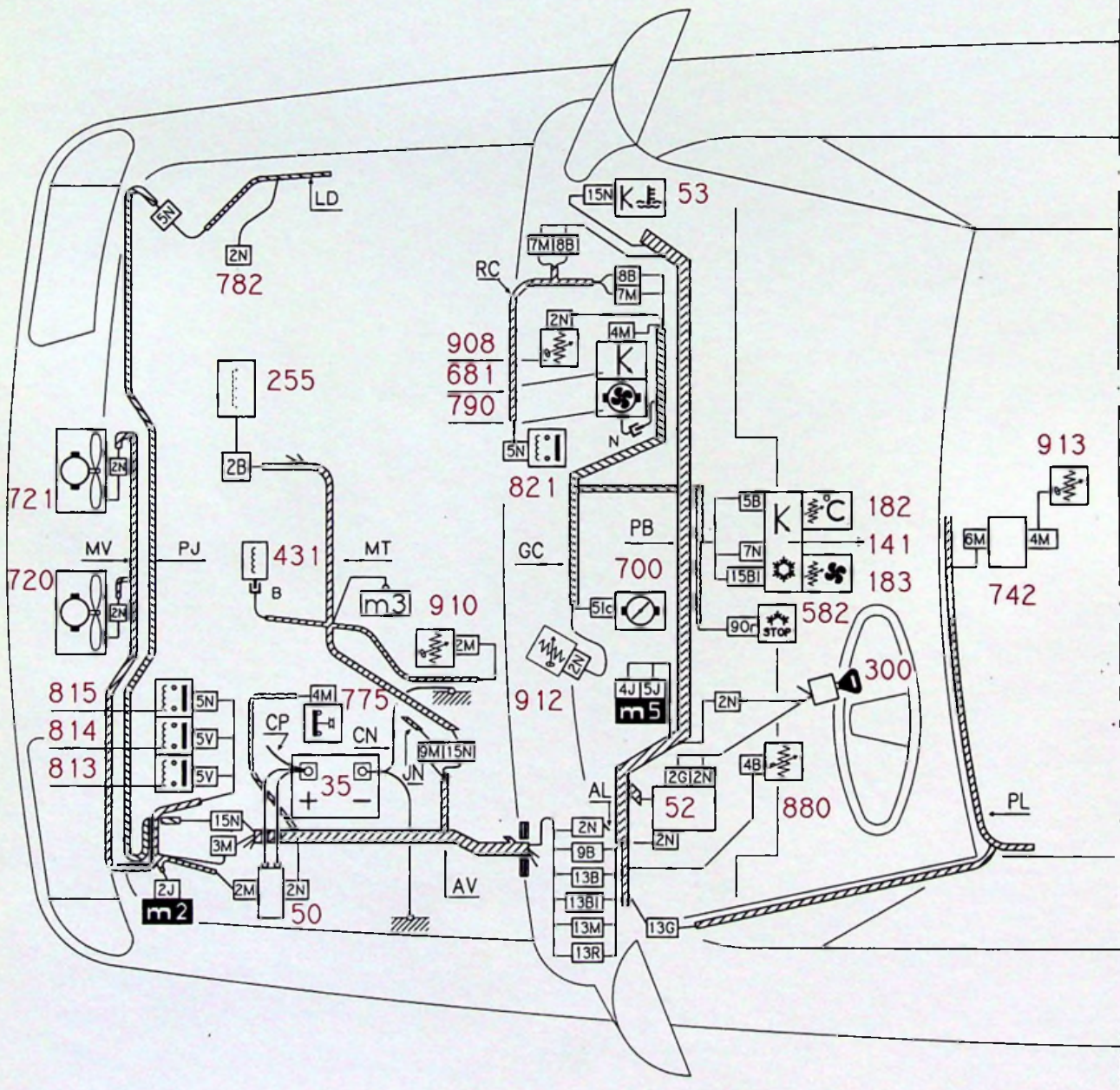



64



XM
643-00/10a

4

5

XM
643-00/10a



64

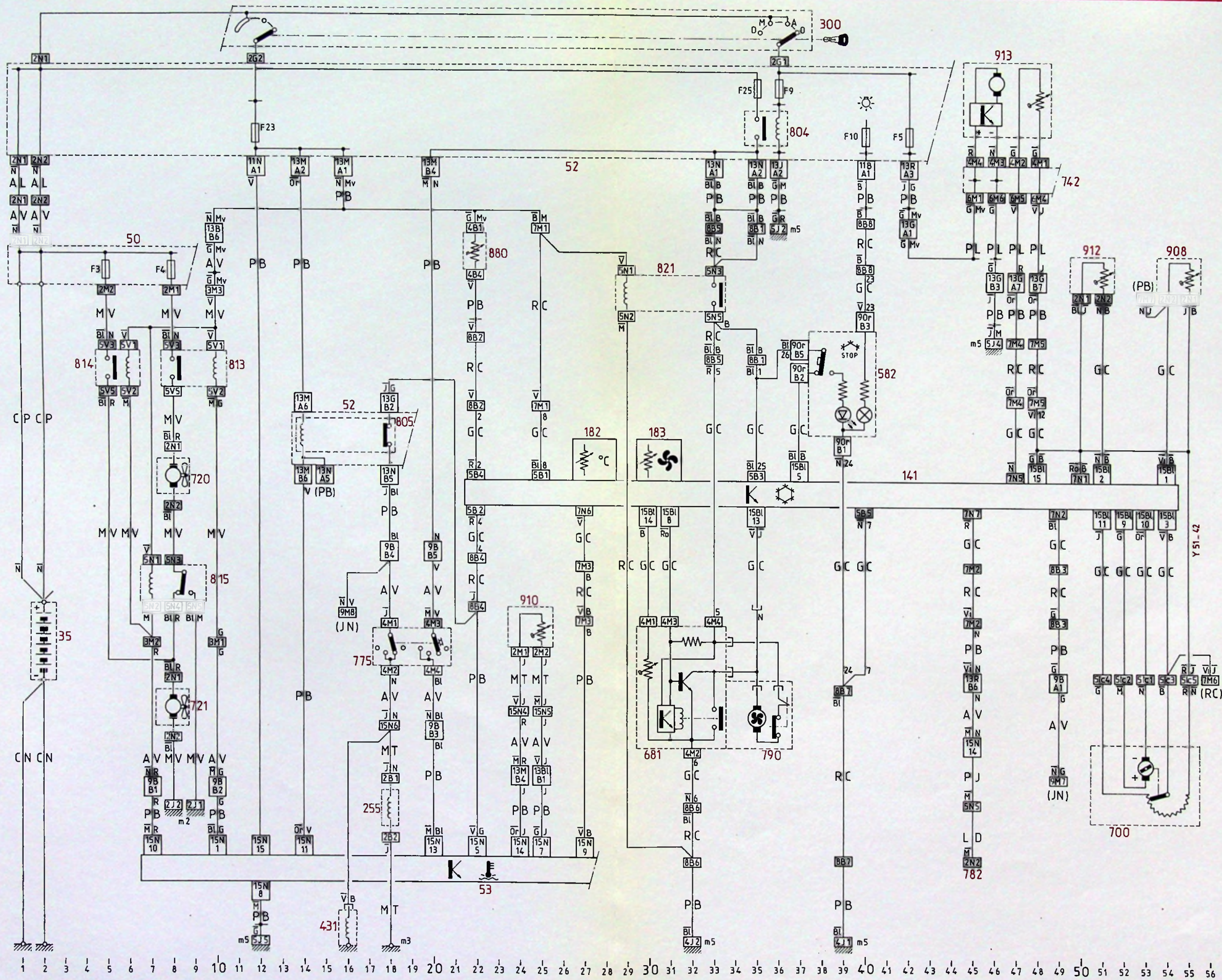



64



XM
643-00/10b

4

5

XM
643-00/10b



64

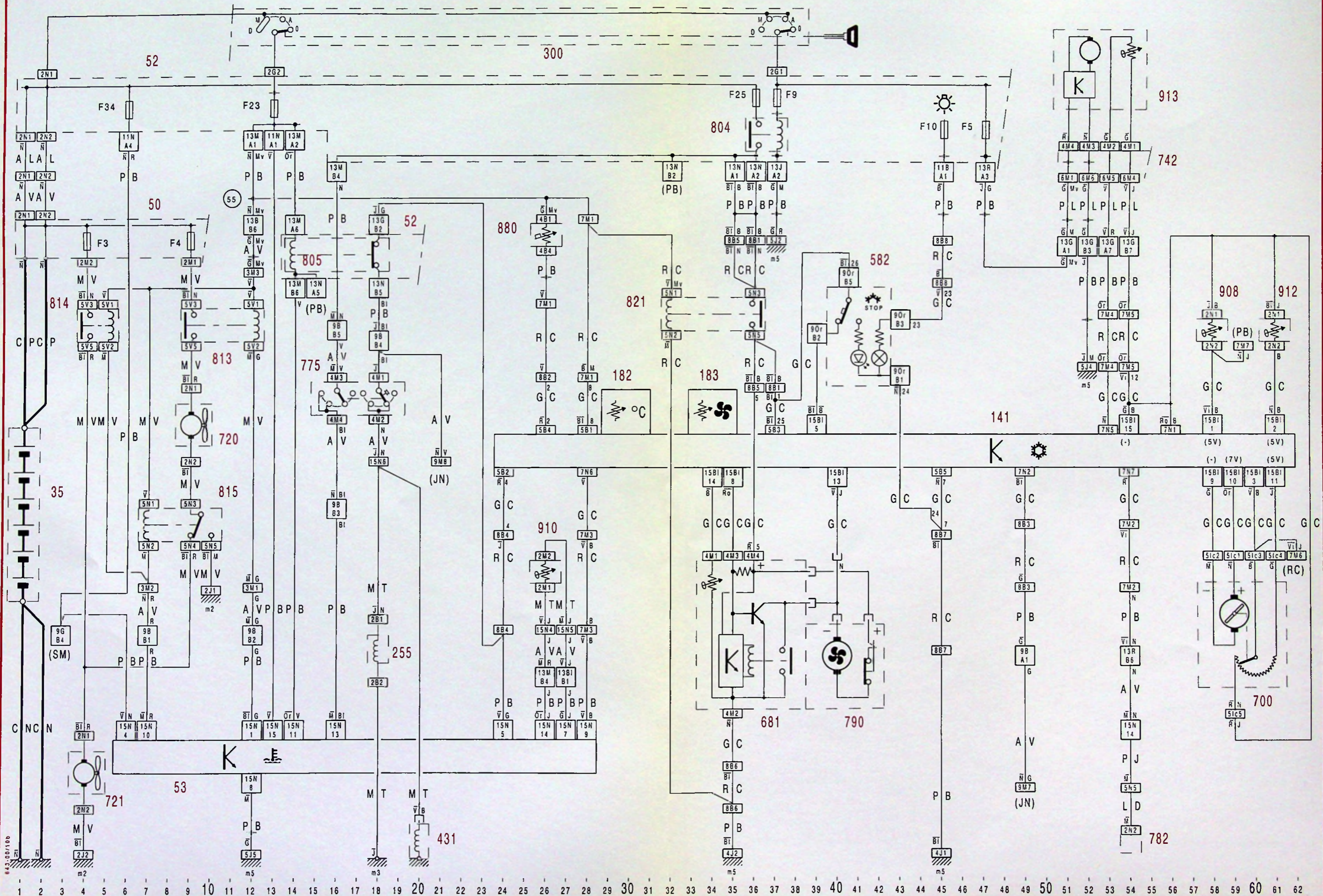

643-00/10b

1 2 3 4 5 6 7 8 9 10 11 12 13 14 15 16 17 18 19 20 21 22 23 24 25 26 27 28 29 30 31 32 33 34 35 36 37 38 39 40 41 42 43 44 45 46 47 48 49 50 51 52 53 54 55 56 57 58 59 60 61 62



64



XM
643-00/11a

4

5

XM
643-00/11a

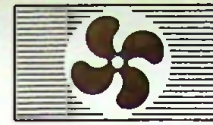

64

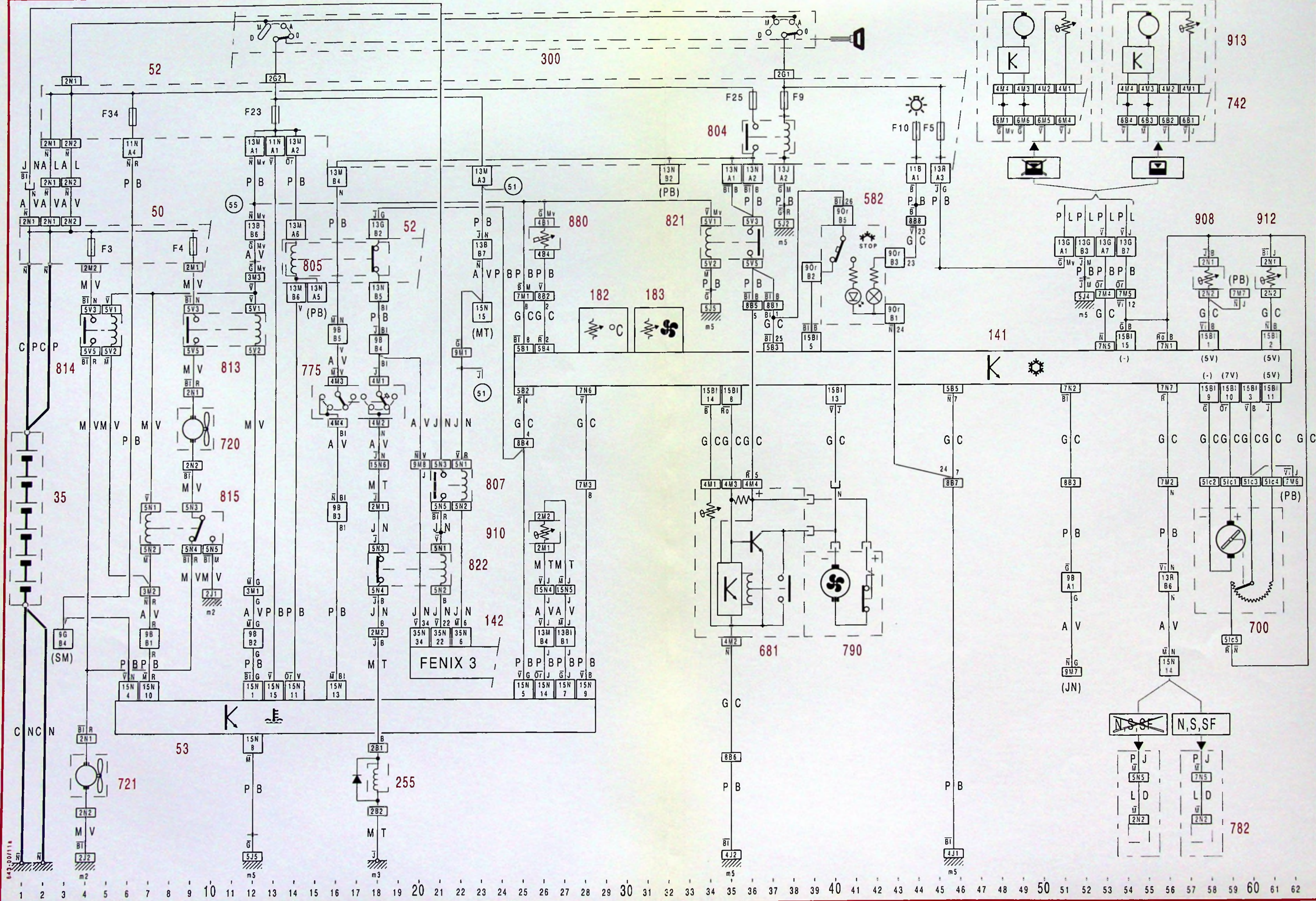



64



XM
643-00/12

4

5

XM
643-00/12



64

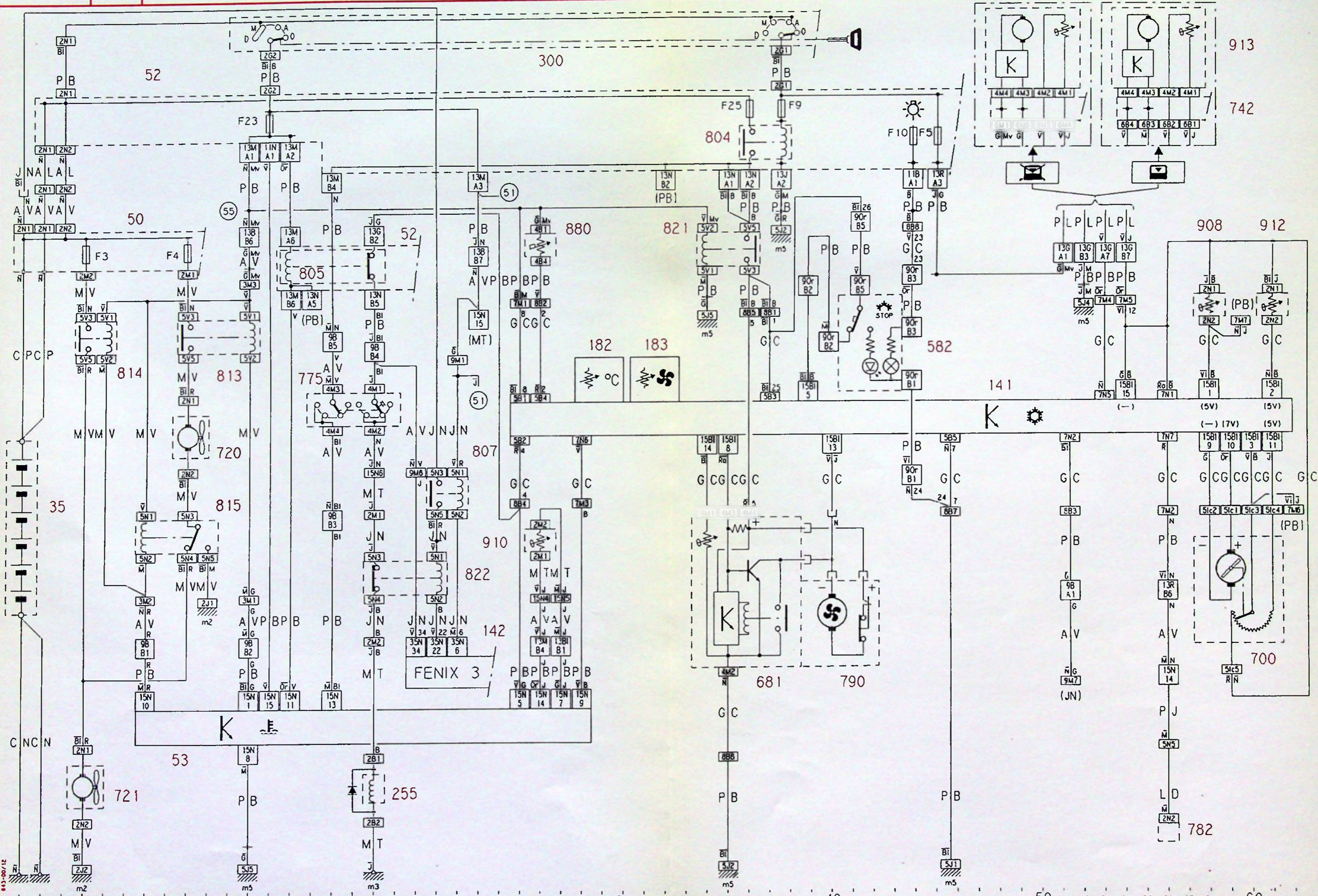

1 2 3 4 5 6 7 8 9 10 11 12 13 14 15 16 17 18 19 20 21 22 23 24 25 26 27 28 29 30 31 32 33 34 35 36 37 38 39 40 41 42 43 44 45 46 47 48 49 50 51 52 53 54 55 56 57 58 59 60 61 62



64



XM
643-00/12a

4

5

XM
643-00/12a



64

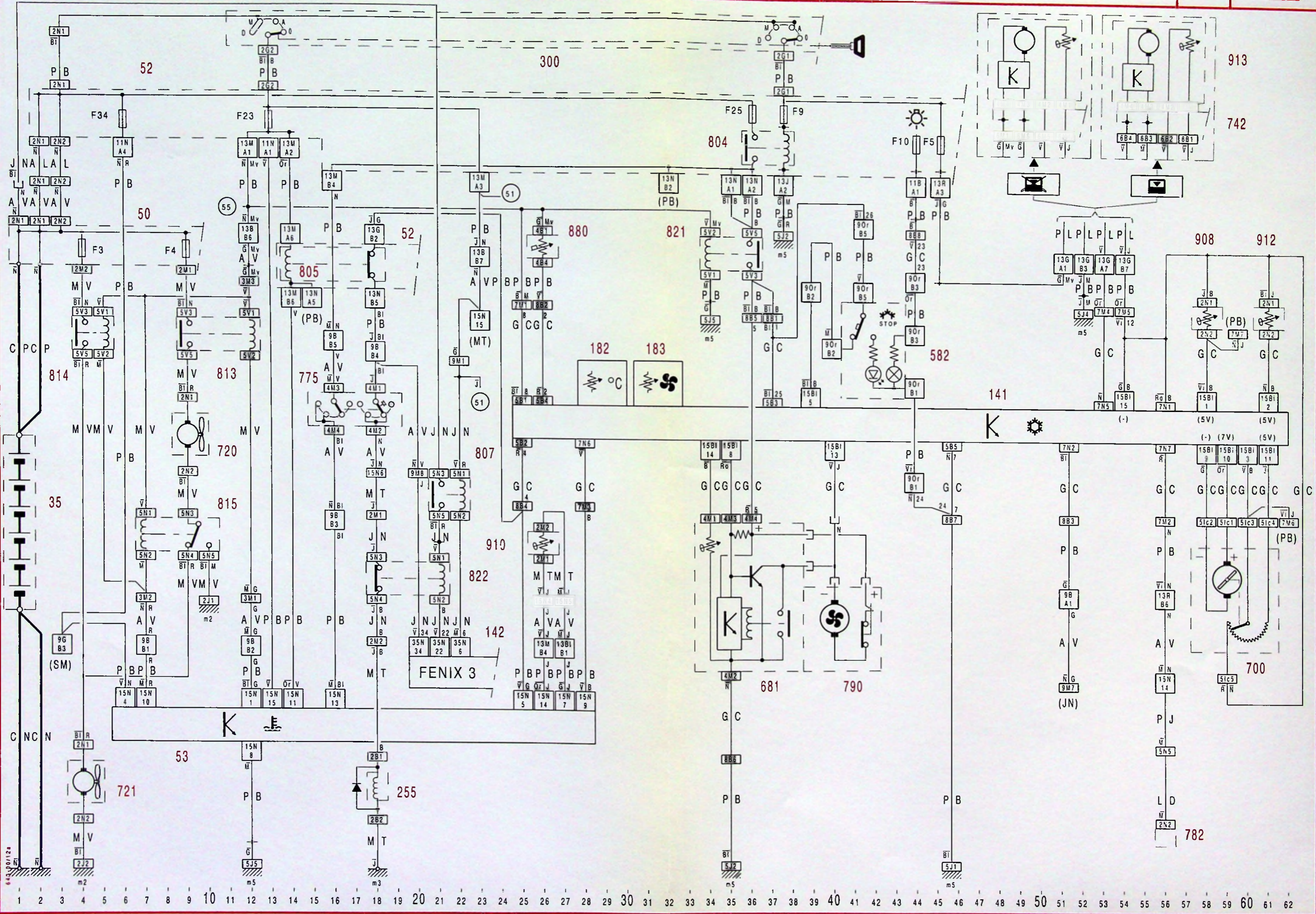

643-00/12a

1 2 3 4 5 6 7 8 9 10 11 12 13 14 15 16 17 18 19 20 21 22 23 24 25 26 27 28 29 30 31 32 33 34 35 36 37 38 39 40 41 42 43 44 45 46 47 48 49 50 51 52 53 54 55 56 57 58 59 60 61 62



64



XM
643-00/13

4

5

XM
643-00/13

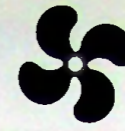

64

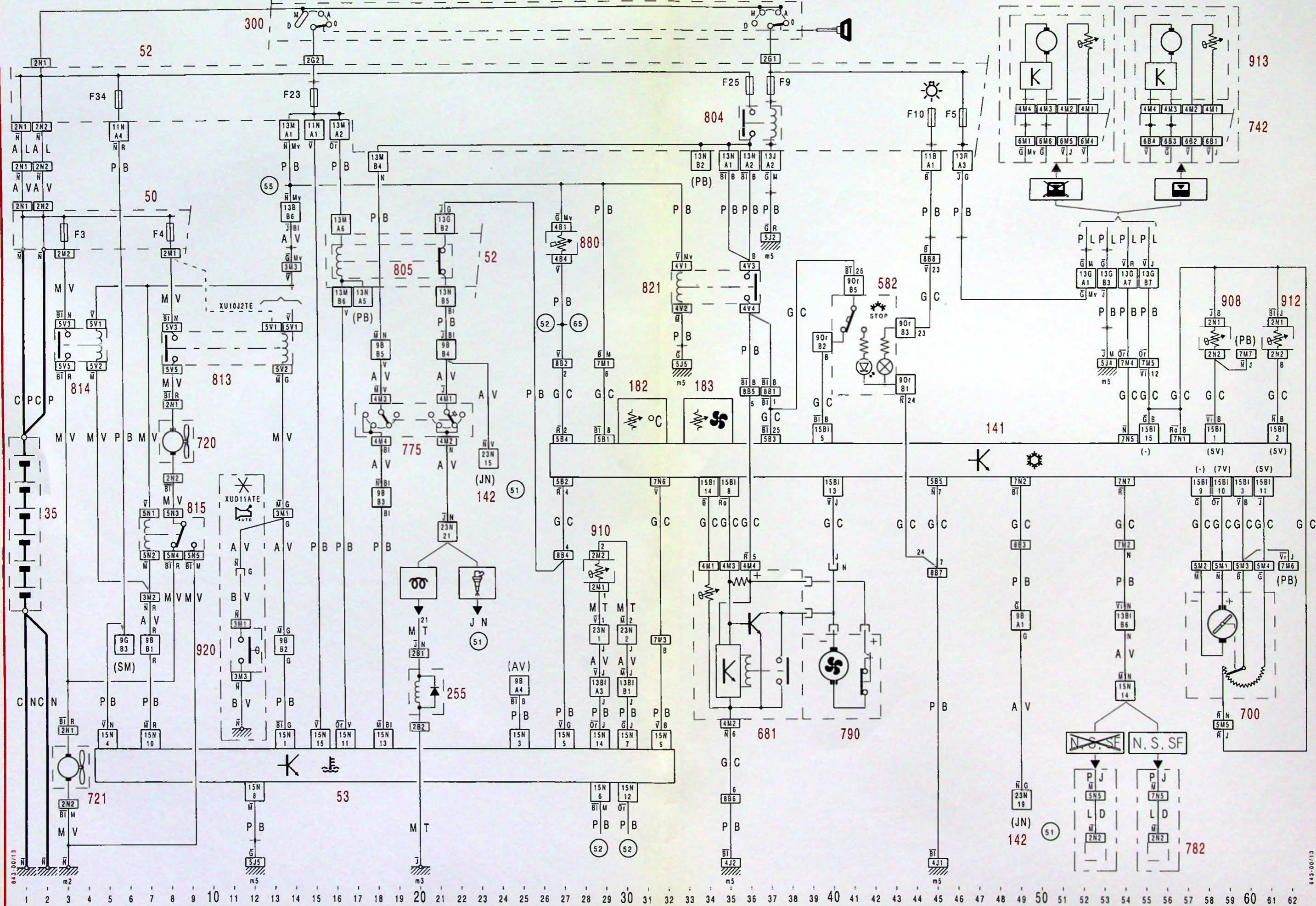

643-00/13

643-00/13



64



XM 643-00/13a

6

7

XM 643-00/13a



64

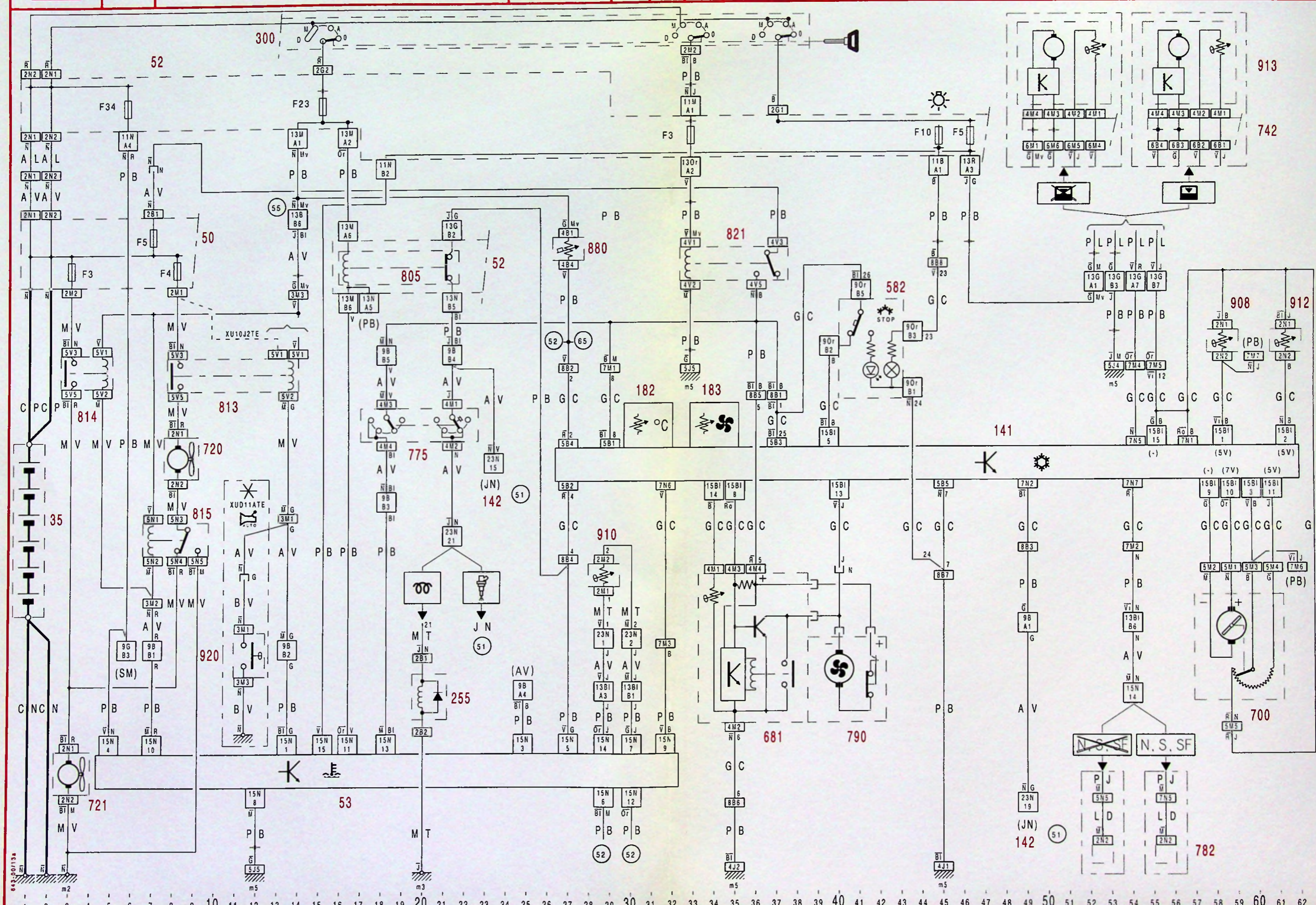

913

742

908

912

(-) (7V) (5V)

700

782

643-00/13a

643-00/13a

1 2 3 4 5 6 7 8 9 10 11 12 13 14 15 16 17 18 19 20 21 22 23 24 25 26 27 28 29 30 31 32 33 34 35 36 37 38 39 40 41 42 43 44 45 46 47 48 49 50 51 52 53 54 55 56 57 58 59 60 61 62



64



XM
643-2/13

4

5

XM
643-2/13



64

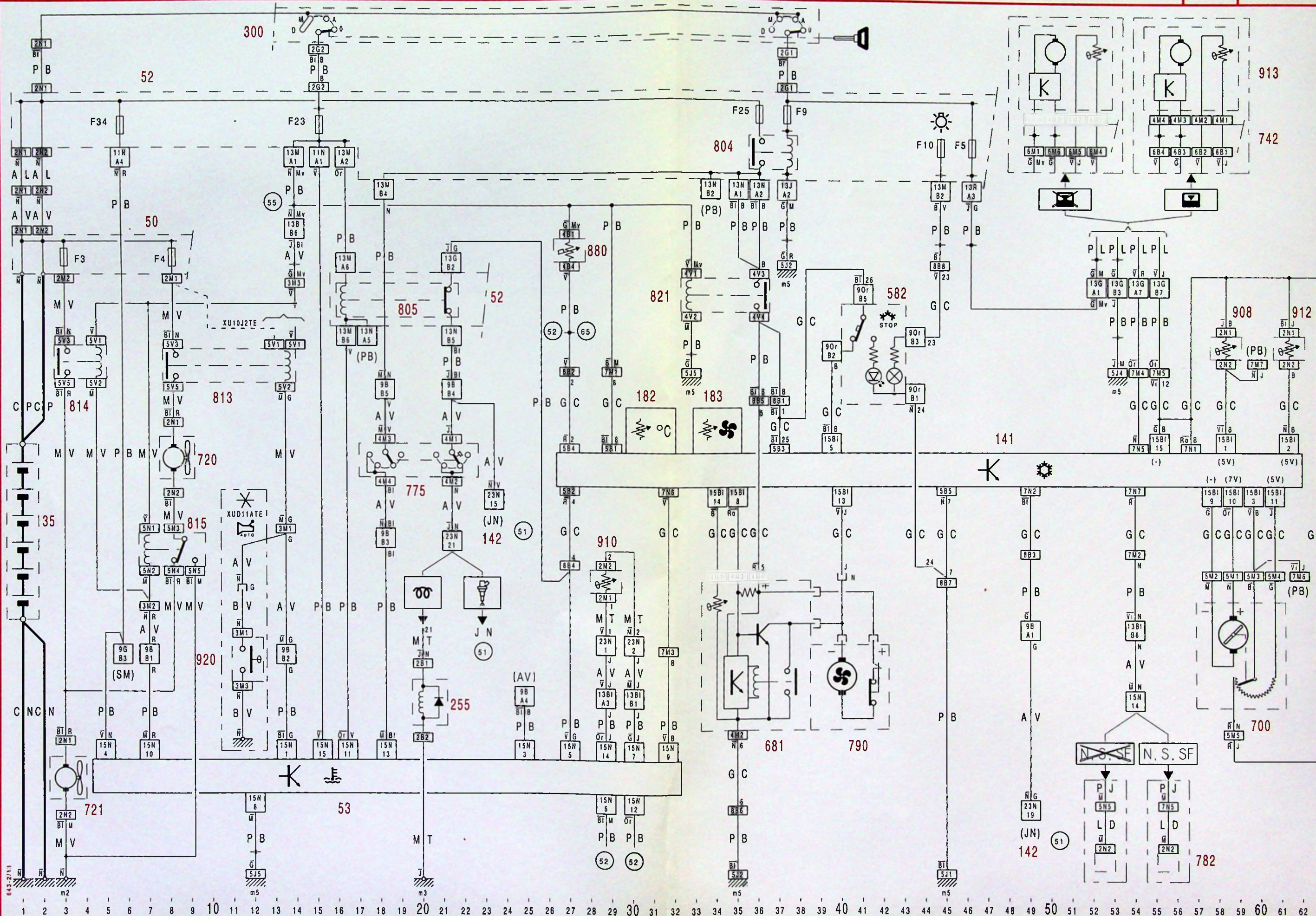

643-2/13

643-2/13



64



XM
644-00/10

1

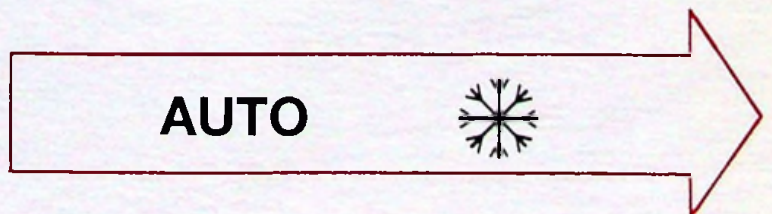



64



XM
643-2/13a

6

7

XM
643-2/13a



64

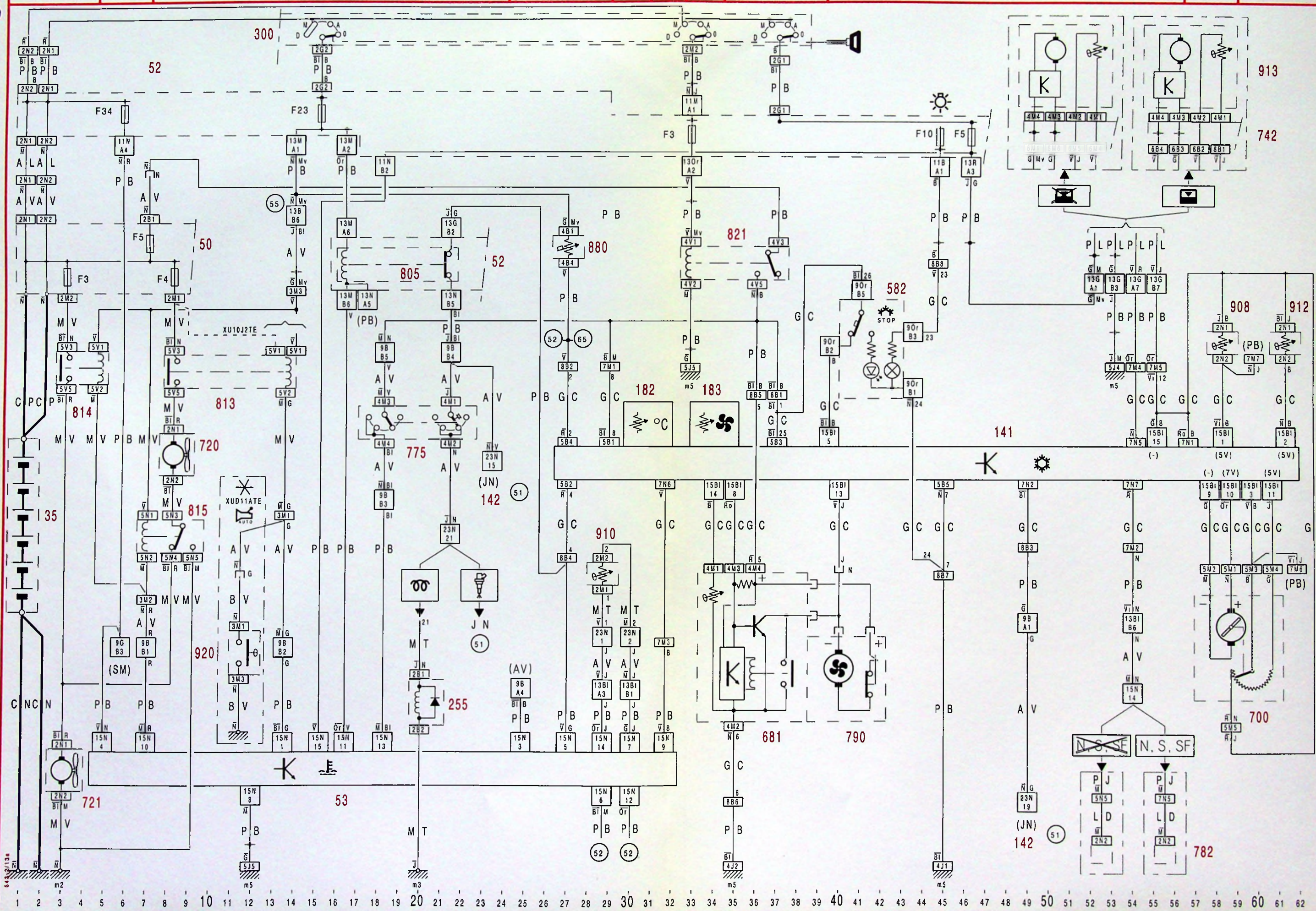

643-2/13a

643-2/13a



64



XM
644-00/10

4

5

XM
644-00/10



64

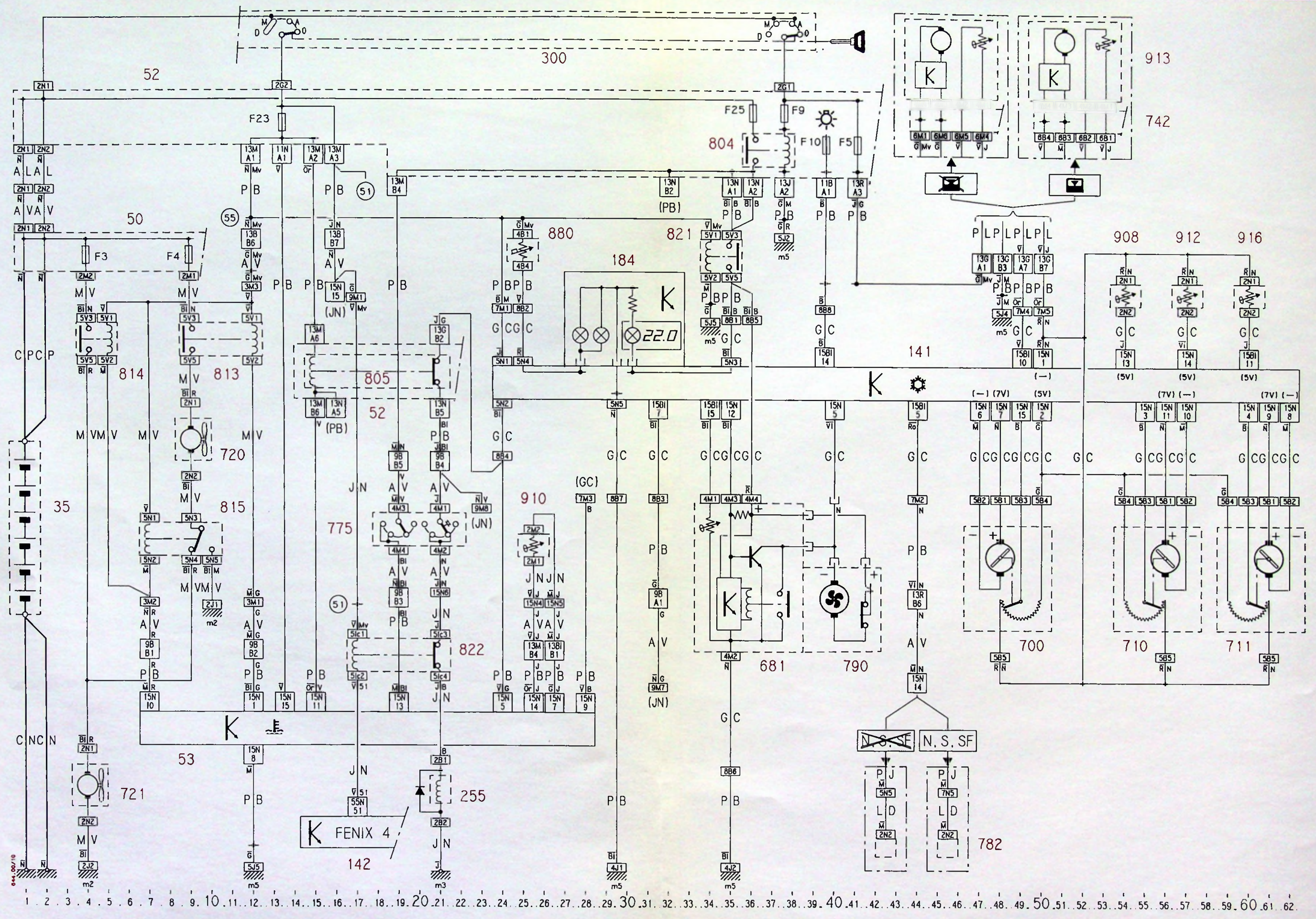

1 2 3 4 5 6 7 8 9 10 11 12 13 14 15 16 17 18 19 20 21 22 23 24 25 26 27 28 29 30 31 32 33 34 35 36 37 38 39 40 41 42 43 44 45 46 47 48 49 50 51 52 53 54 55 56 57 58 59 60 61 62



64



XM
644-00/10b

4

5

XM
644-00/10b

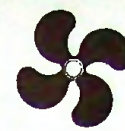
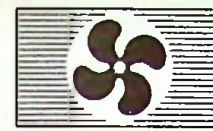

64

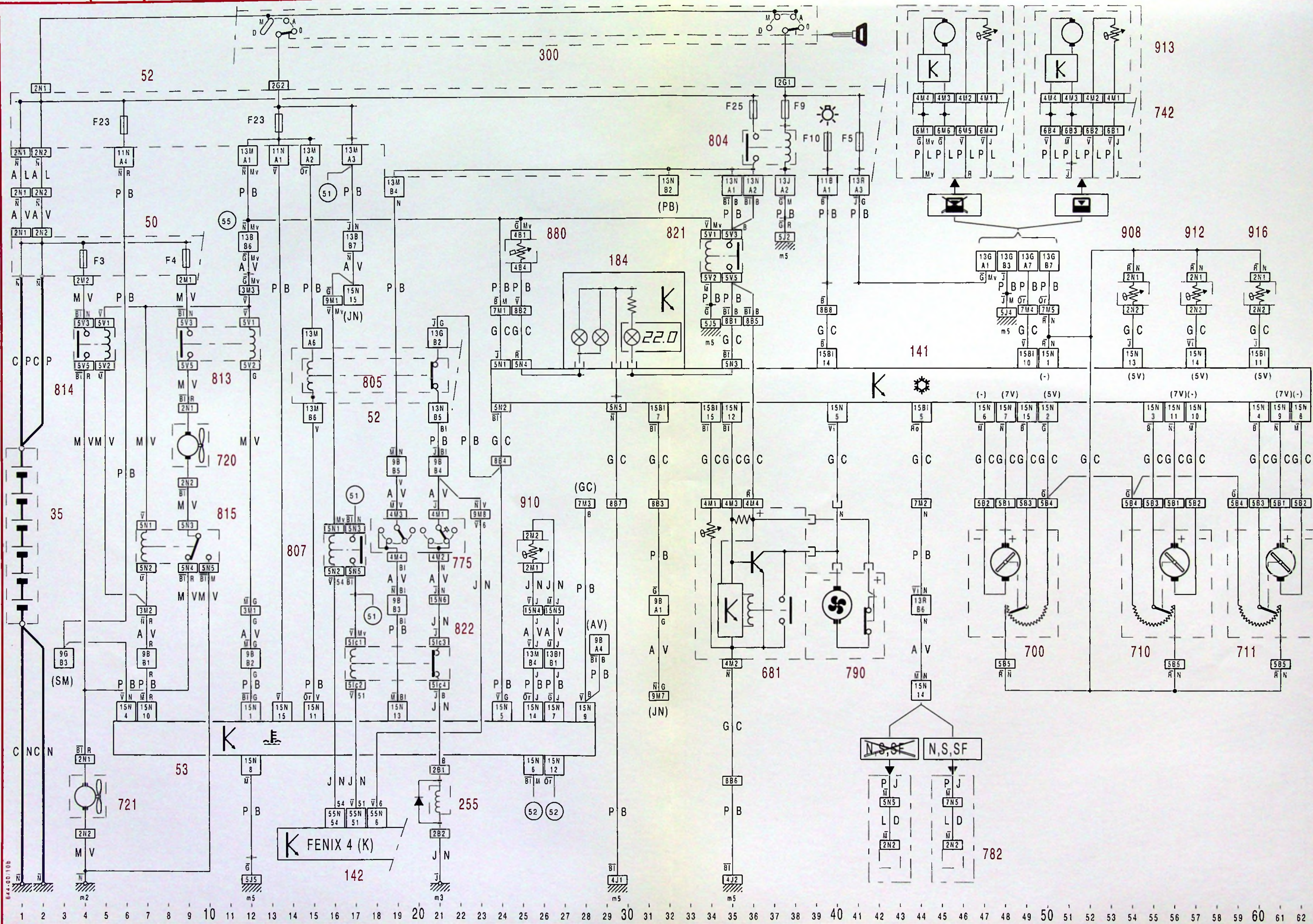



64



XM
644-00/11

1

Niveau 4 AUTO 

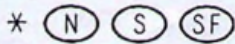
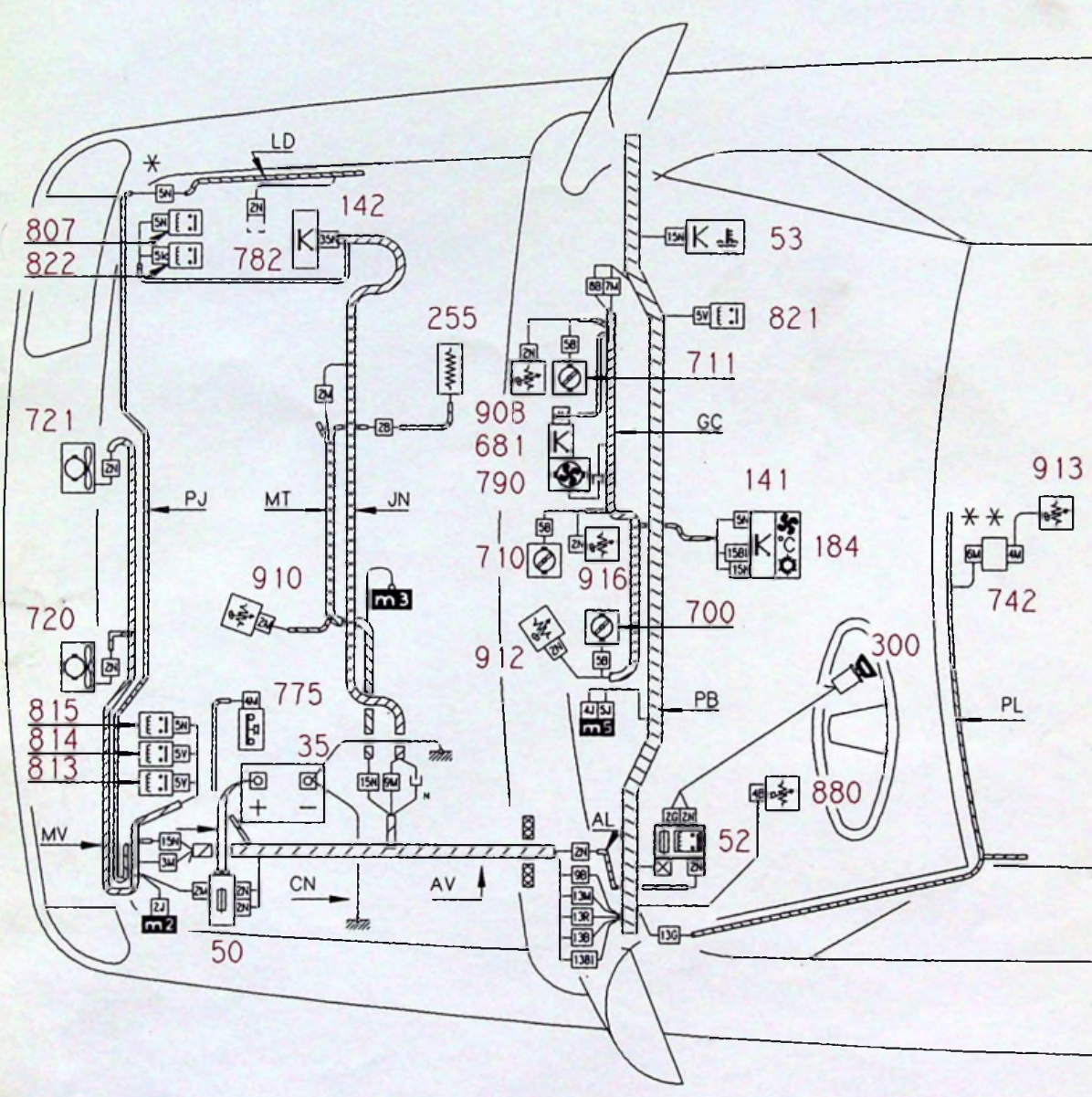

**

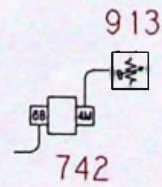



64



XM
644-00/11

4

5

XM
644-00/11



64

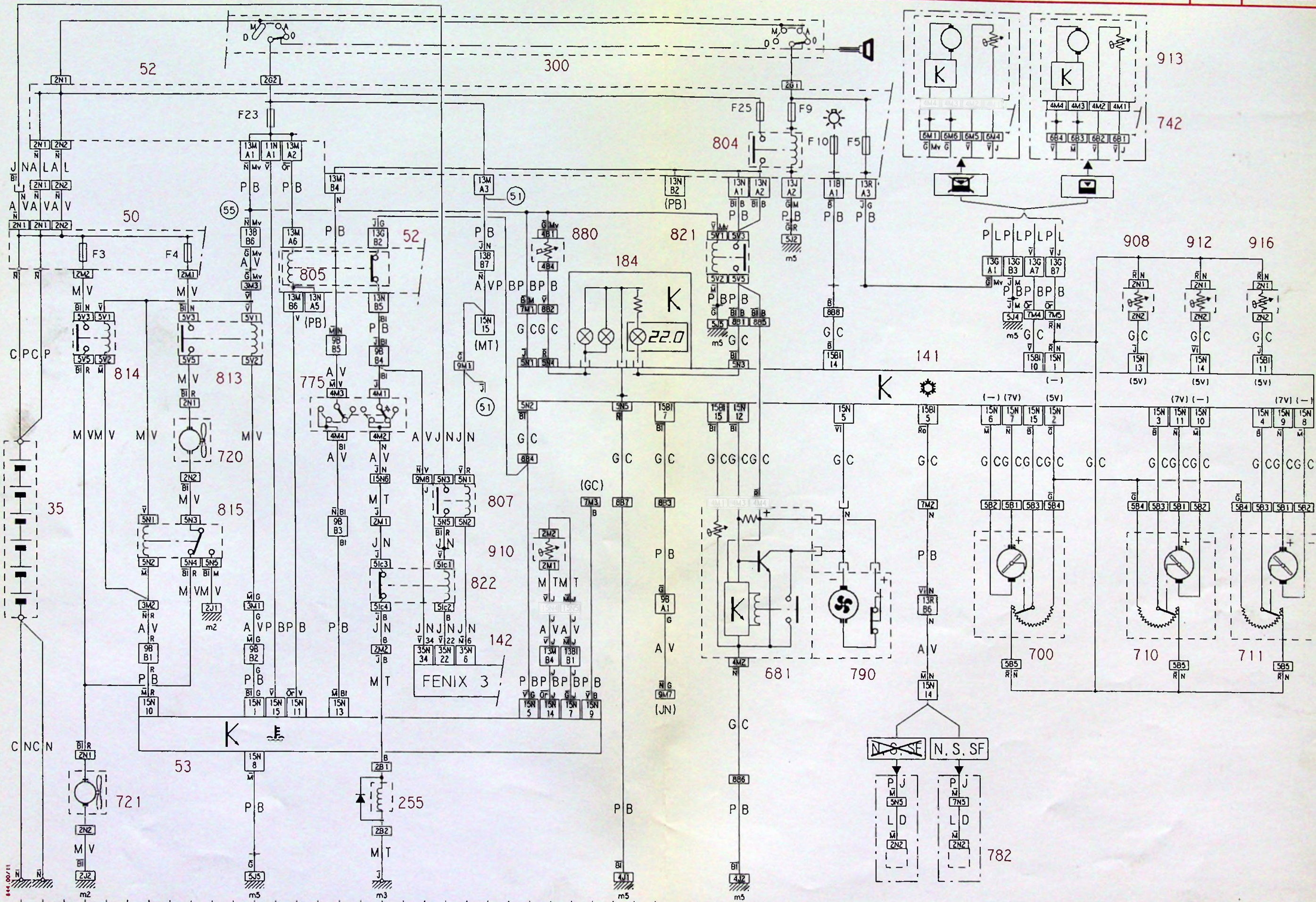

1 2 3 4 5 6 7 8 9 10 11 12 13 14 15 16 17 18 19 20 21 22 23 24 25 26 27 28 29 30 31 32 33 34 35 36 37 38 39 40 41 42 43 44 45 46 47 48 49 50 51 52 53 54 55 56 57 58 59 60 61 62



64



XM
644-00/11a

4

5

XM
644-00/11a

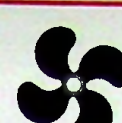
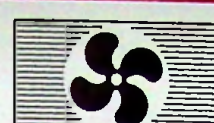

64

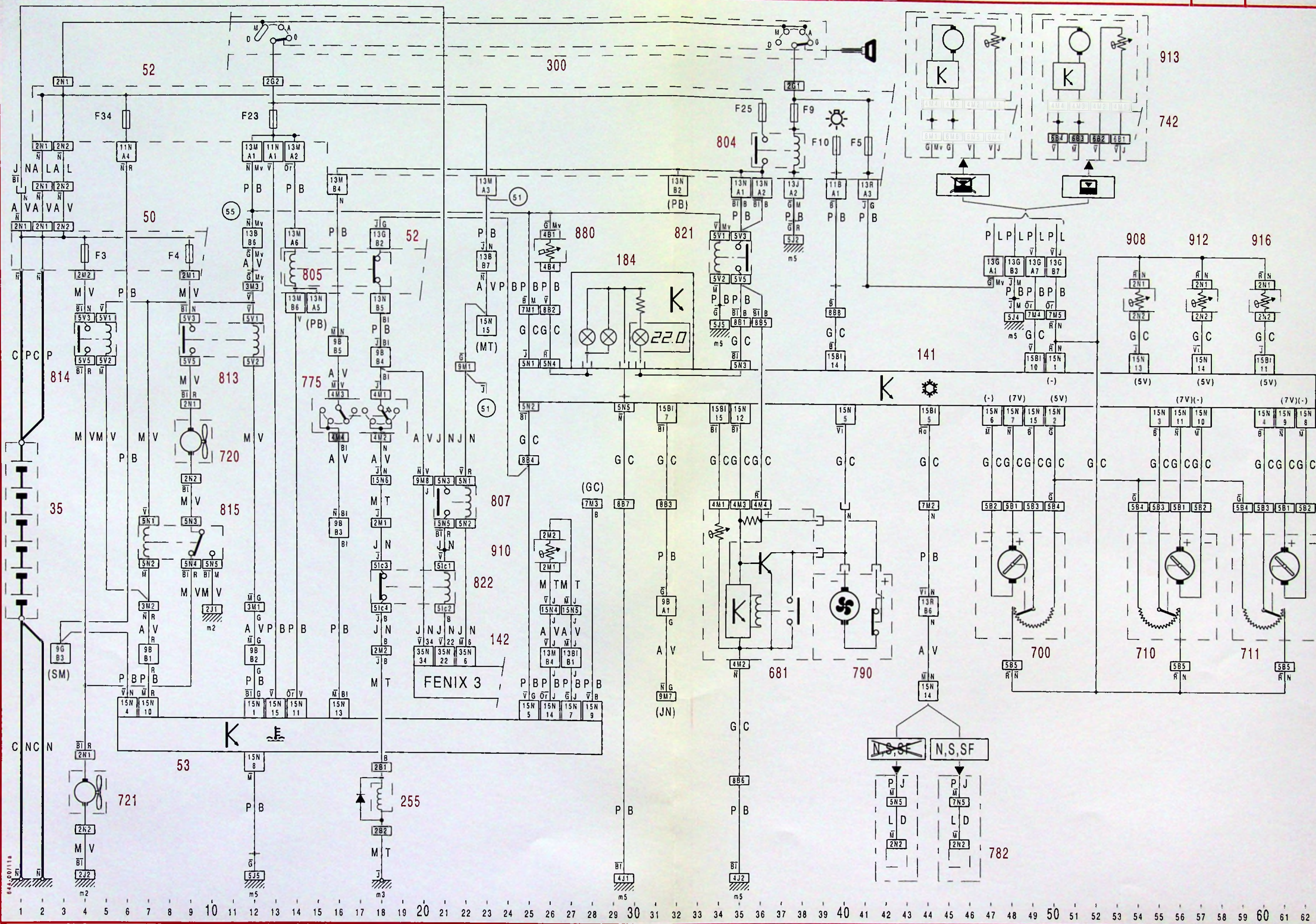

644-00/11a



64



XM
644-00/12

4

5

XM
644-00/12



64

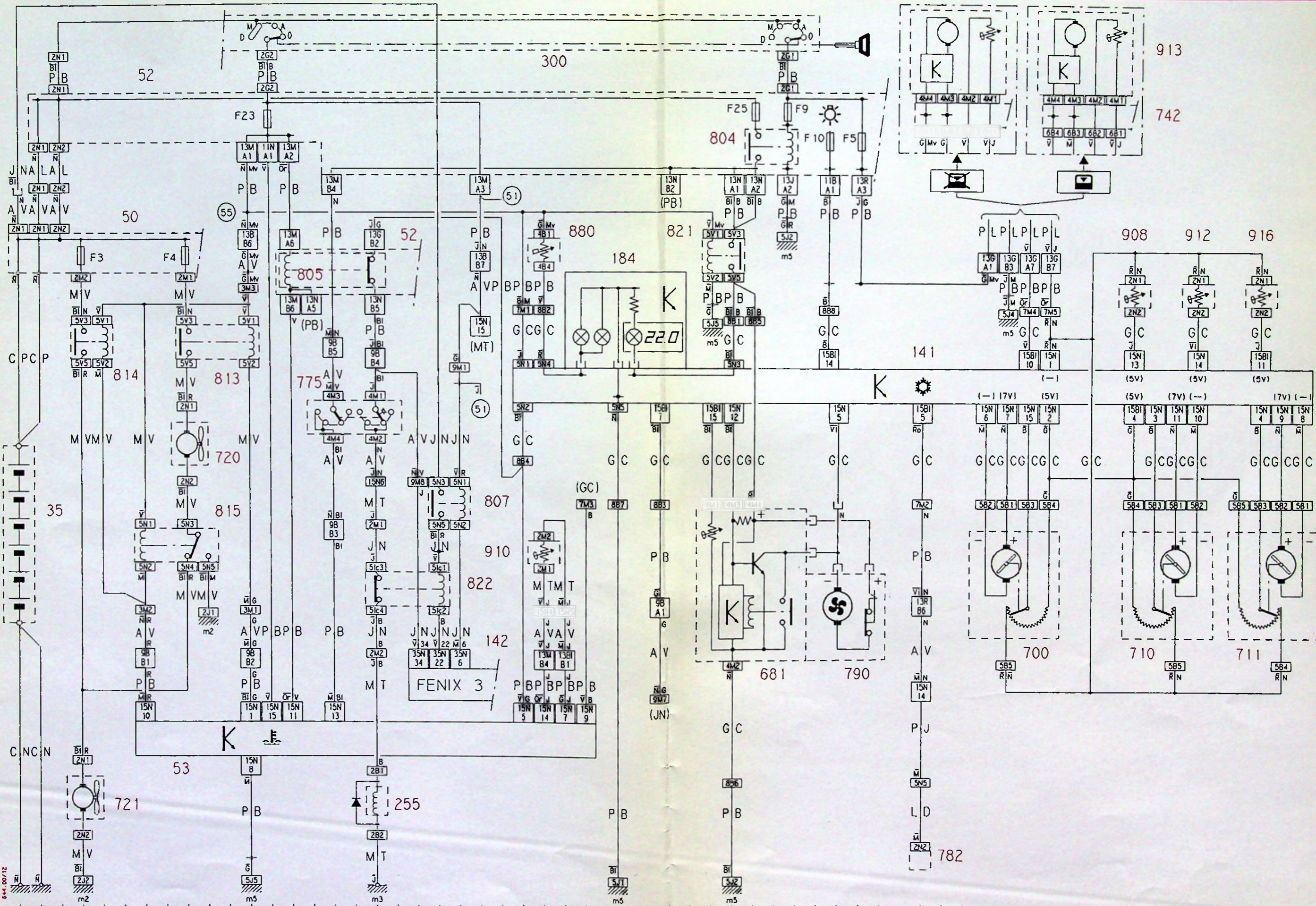

1 2 3 4 5 6 7 8 9 10 11 12 13 14 15 16 17 18 19 20 21 22 23 24 25 26 27 28 29 30 31 32 33 34 35 36 37 38 39 40 41 42 43 44 45 46 47 48 49 50 51 52 53 54 55 56 57 58 59 60 61 62



64



XM
644-00/12a

4

5

XM
644-00/12a

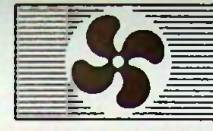

64

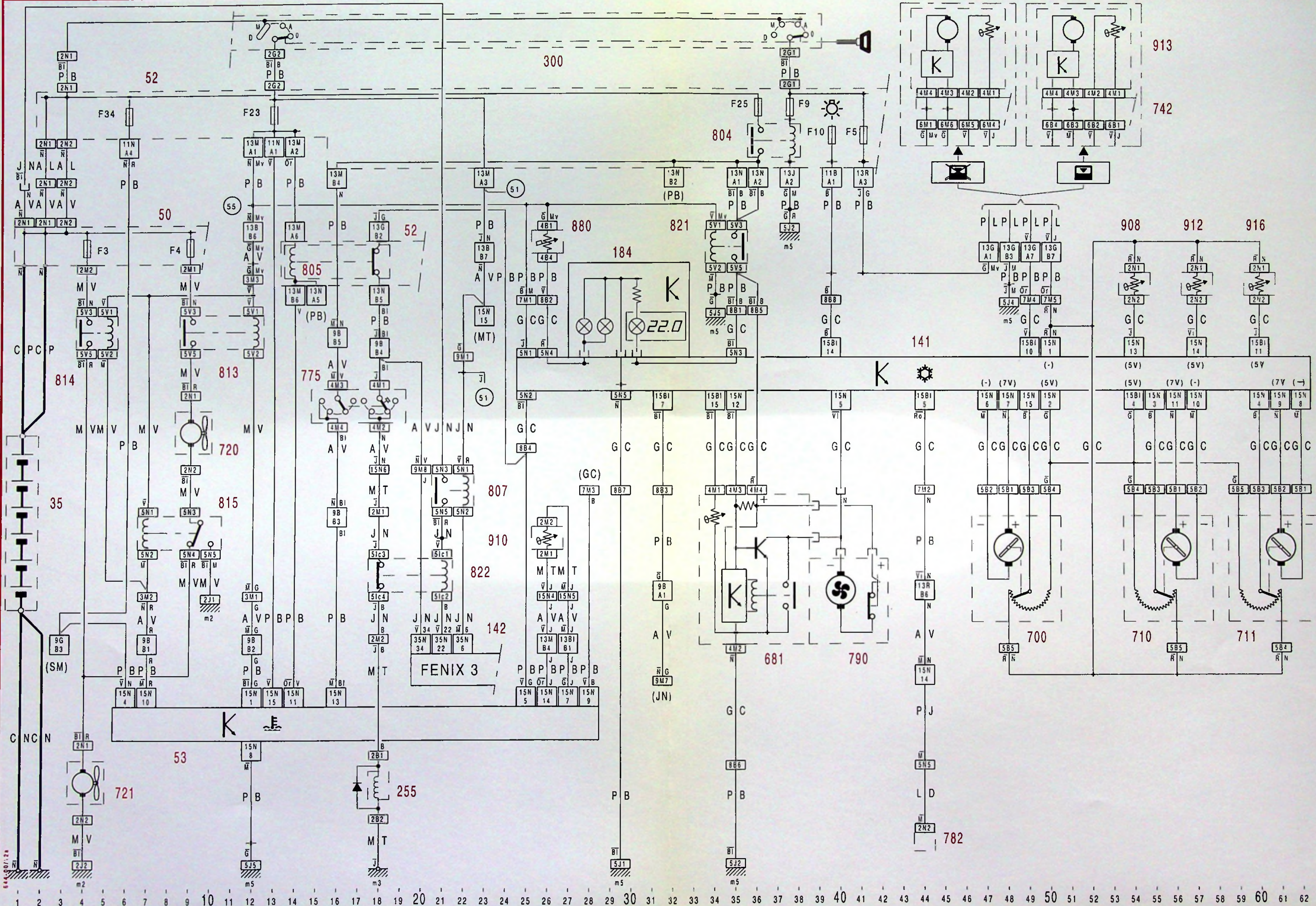

1 2 3 4 5 6 7 8 9 10 11 12 13 14 15 16 17 18 19 20 21 22 23 24 25 26 27 28 29 30 31 32 33 34 35 36 37 38 39 40 41 42 43 44 45 46 47 48 49 50 51 52 53 54 55 56 57 58 59 60 61 62



64



XM
644-00/13a

4

5

XM
644-00/13a



64

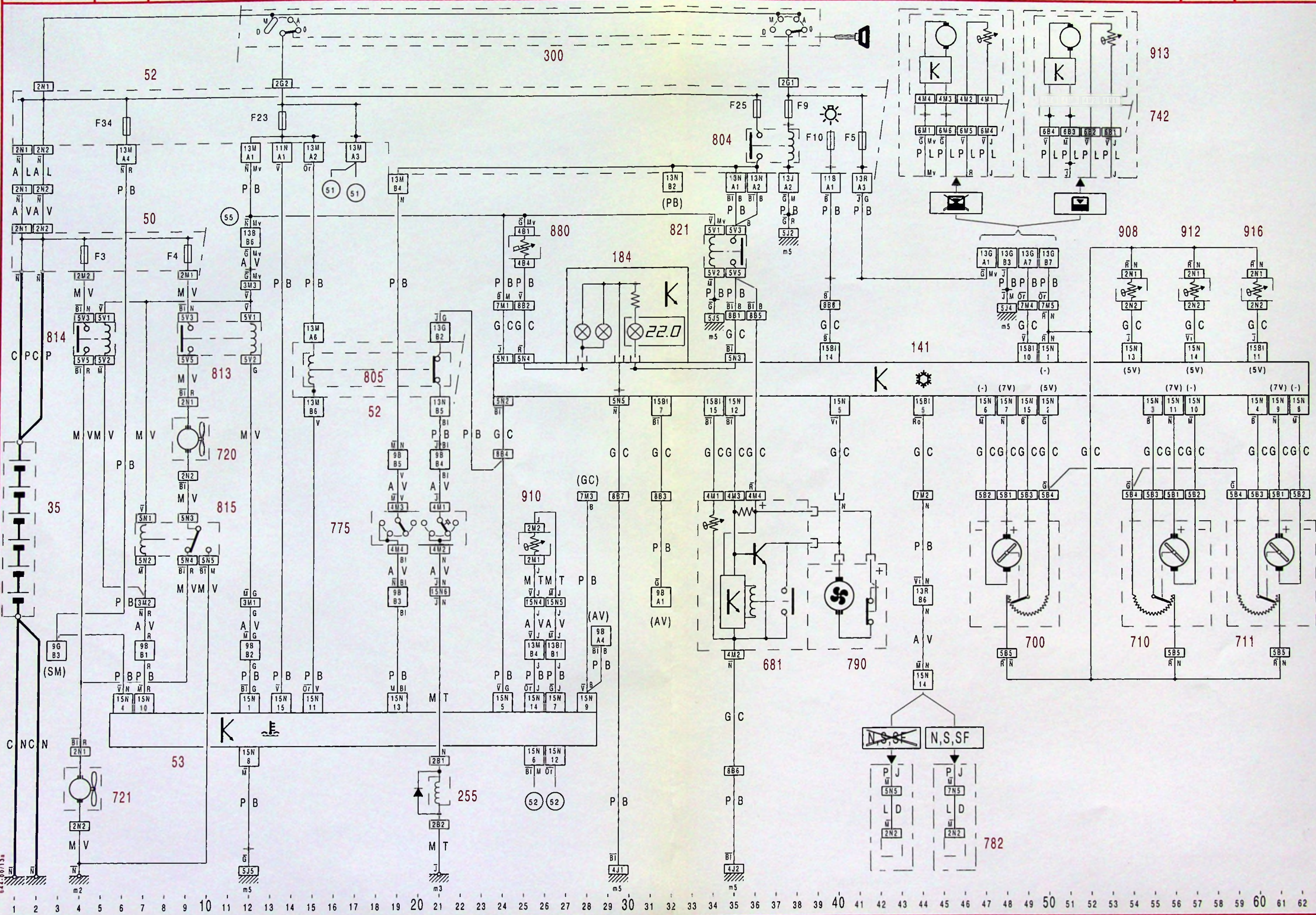

644-00/13a

1 2 3 4 5 6 7 8 9 10 11 12 13 14 15 16 17 18 19 20 21 22 23 24 25 26 27 28 29 30 31 32 33 34 35 36 37 38 39 40 41 42 43 44 45 46 47 48 49 50 51 52 53 54 55 56 57 58 59 60 61 62



64



XM
644-00/14a

4

5

XM
644-00/14a



64

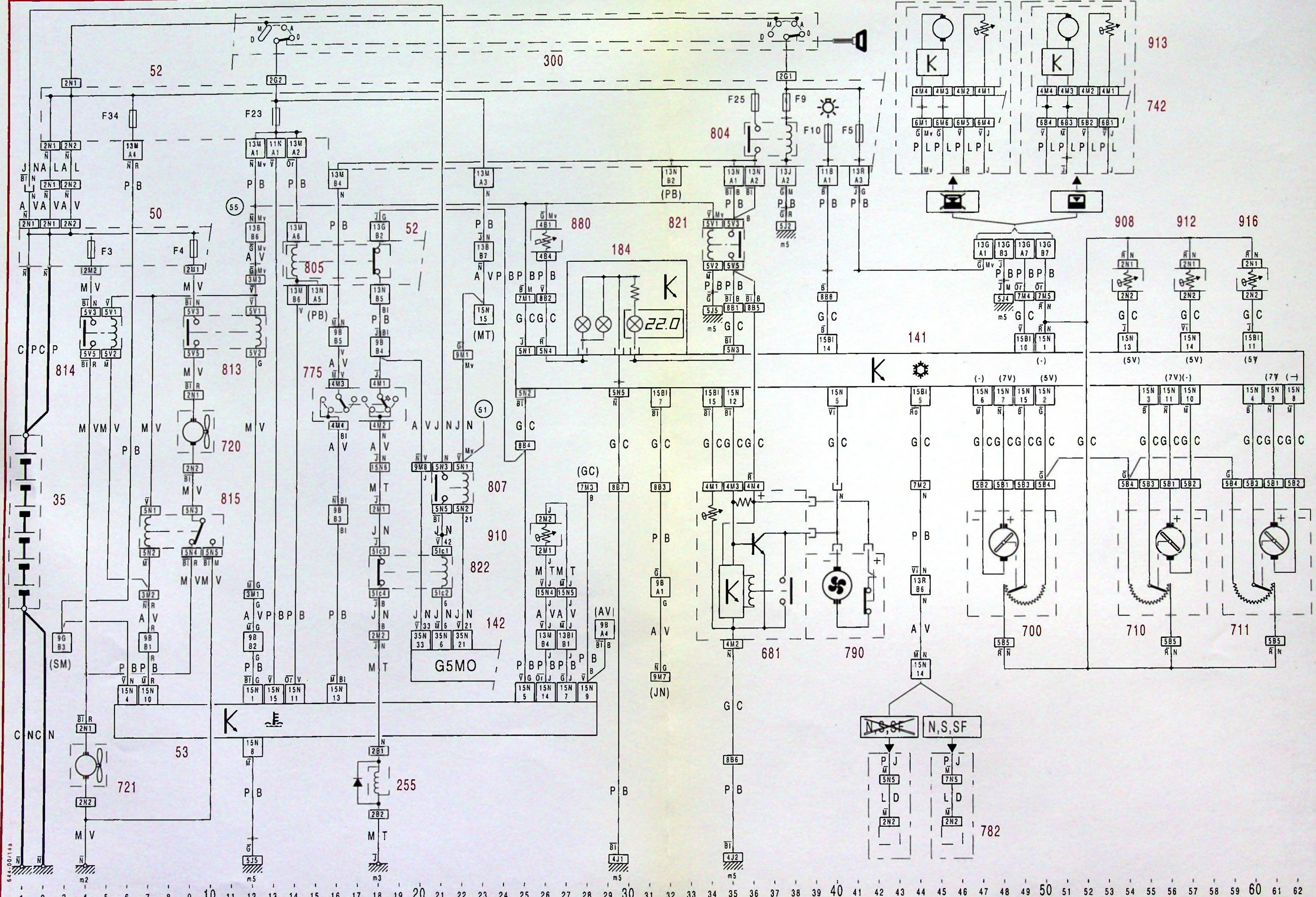

644-00/14a

1 2 3 4 5 6 7 8 9 10 11 12 13 14 15 16 17 18 19 20 21 22 23 24 25 26 27 28 29 30 31 32 33 34 35 36 37 38 39 40 41 42 43 44 45 46 47 48 49 50 51 52 53 54 55 56 57 58 59 60 61 62



64



XM
644-00/15

4

5

XM
644-00/15

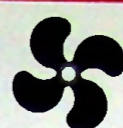

64

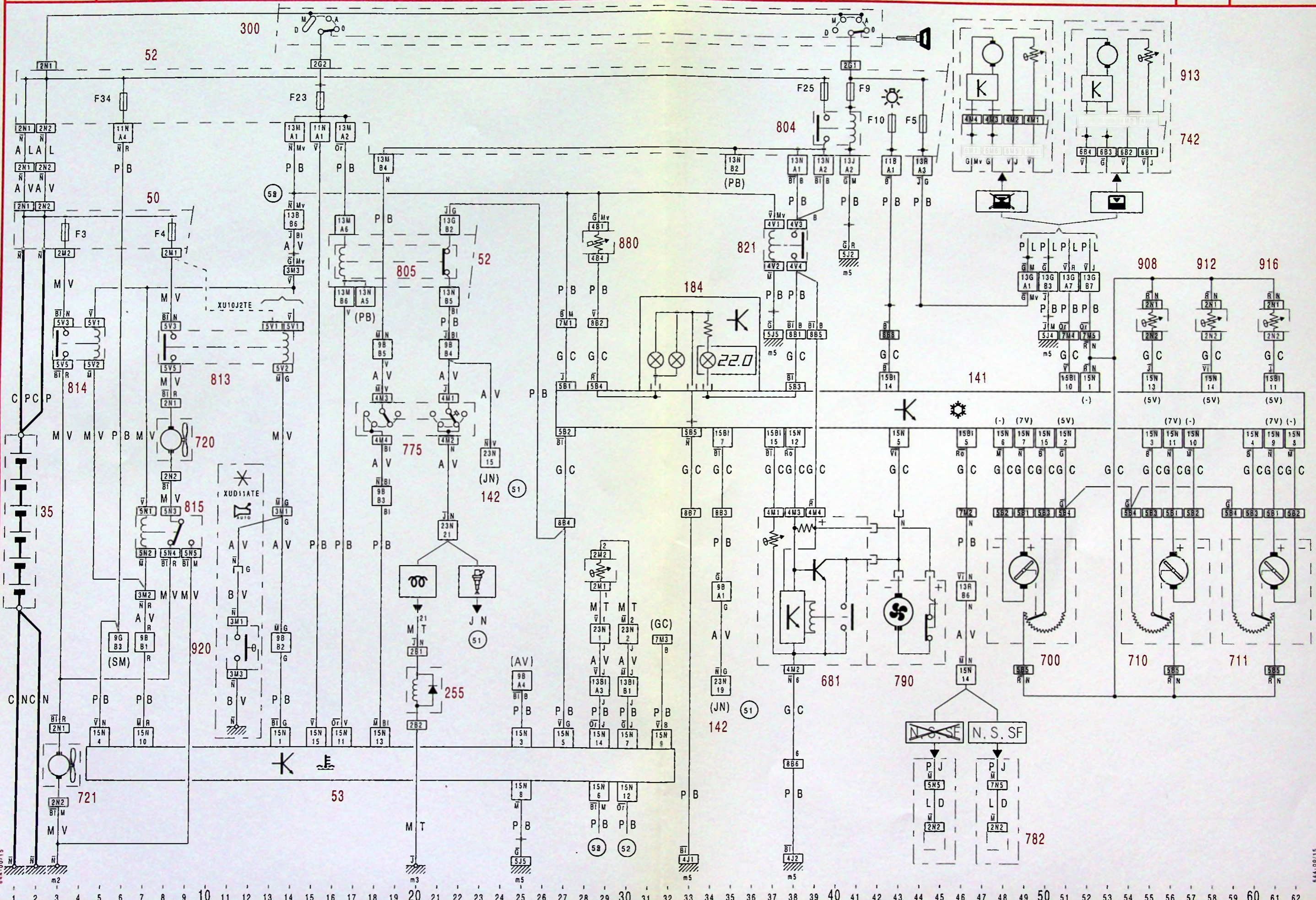

644-00/15

644-00/15



64



XM
644-00/15a

6

7

XM
644-00/15a



64

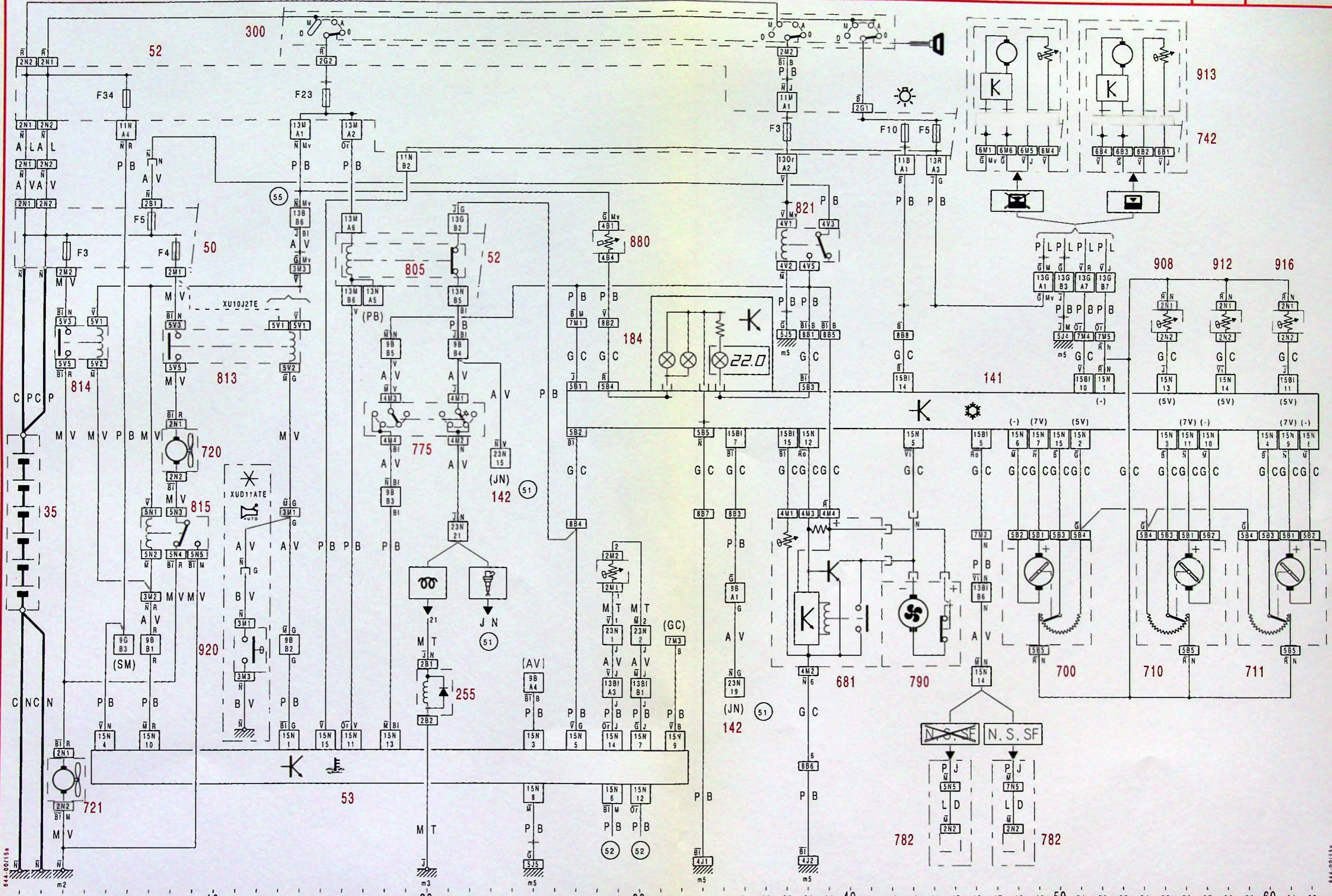

644-00/15a

644-00/15a



64



XM
644-2/15

4

5

XM
644-2/15

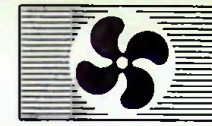

64

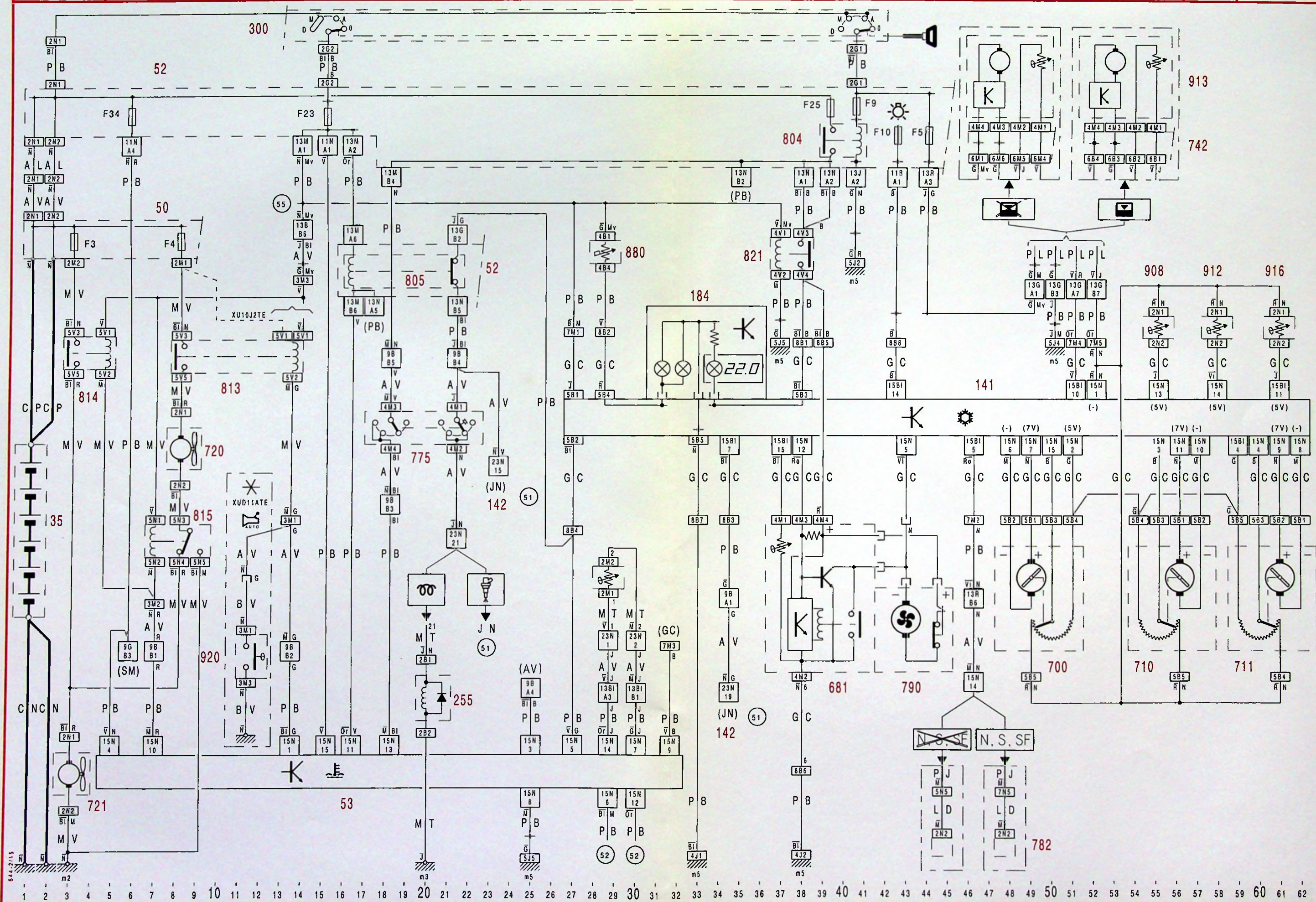

644-2/15

644-2/15



64



XM
644-2/15a

6

7

XM
644-2/15a



64

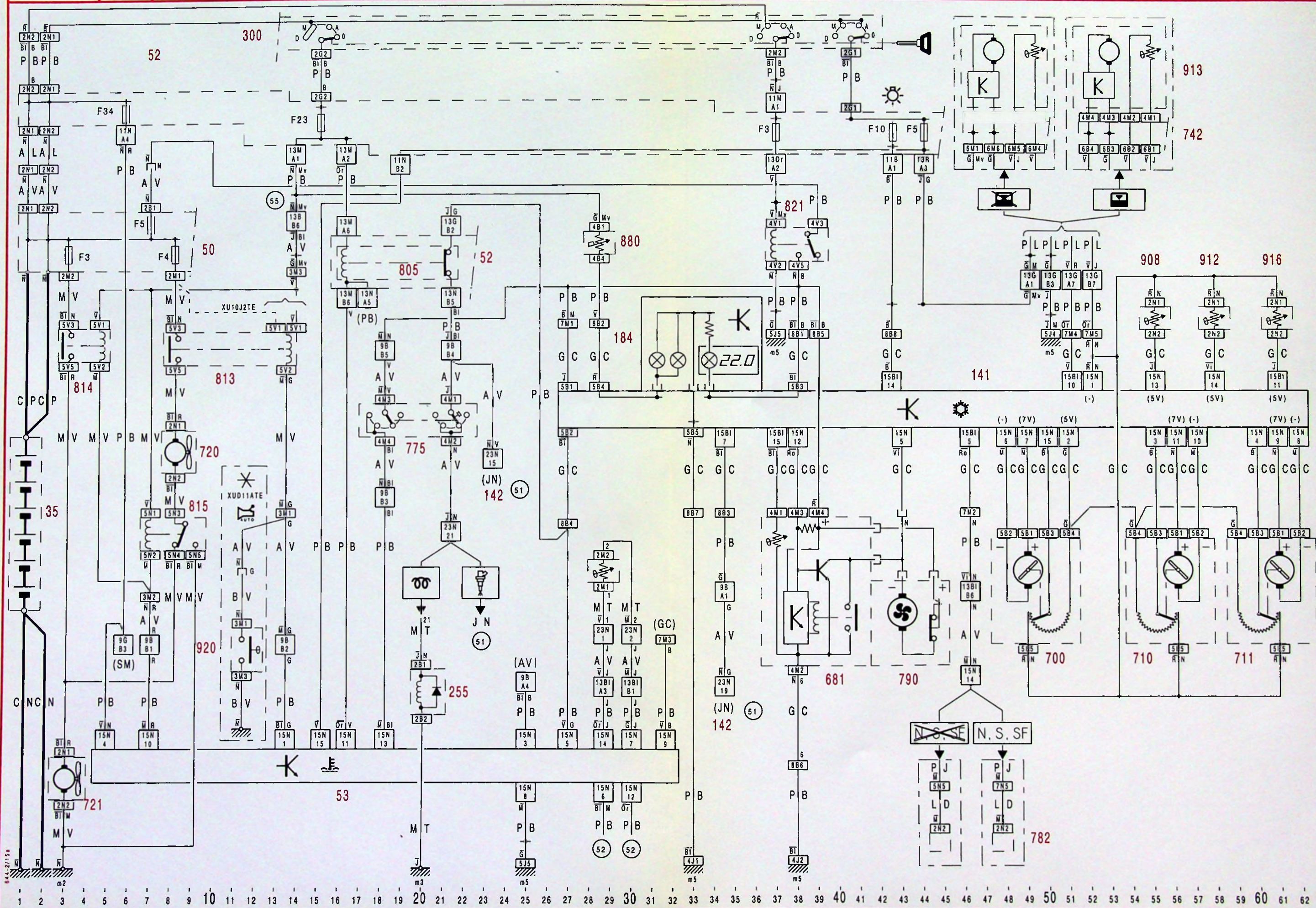

644-2/15a

644-2/15a