



67



XM
670-000/1

1

FONCTION : OUVRANTS

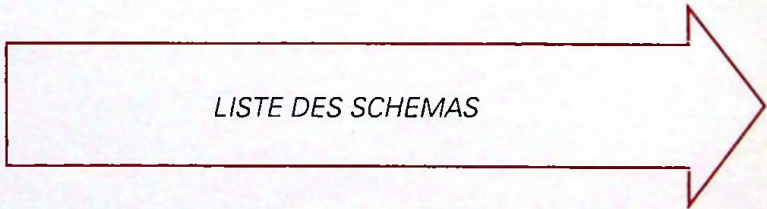

LISTE DES SCHEMAS



COMMANDE LEVE-VITRES

NUMERO	DIRECTION	VALIDITE	DESIGNATION
671-00/20	Gauche		COMMANDE A IMPULSIONS

COMMANDE FERMETURE PORTES

NUMERO	DIRECTION	VALIDITE	DESIGNATION
672-00/05	Gauche		VEHICULE sans AFFICHEUR GAUCHE
672-00/10	Gauche		VEHICULE avec SILHOUETTE AUTO
672-00/20	Gauche		VEHICULE avec MATRICE DE POINTS

COMMANDE TOIT OUVRANT

NUMERO	DIRECTION	VALIDITE	DESIGNATION
673-00/20	Gauche		XM TT

ALARME

NUMERO	DIRECTION	VALIDITE	DESIGNATION
675-0/10	Gauche	07/93 →	VEHICULE avec SILHOUETTE AUTO
675-0/30	Gauche	07/93 →	VEHICULE avec MATRICE DE POINTS



67



XM
672-00/05

1

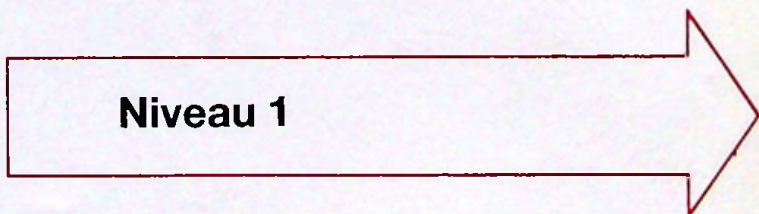

Niveau 1



67



XM
672-00/05

3

4

XM
672-00/05



67

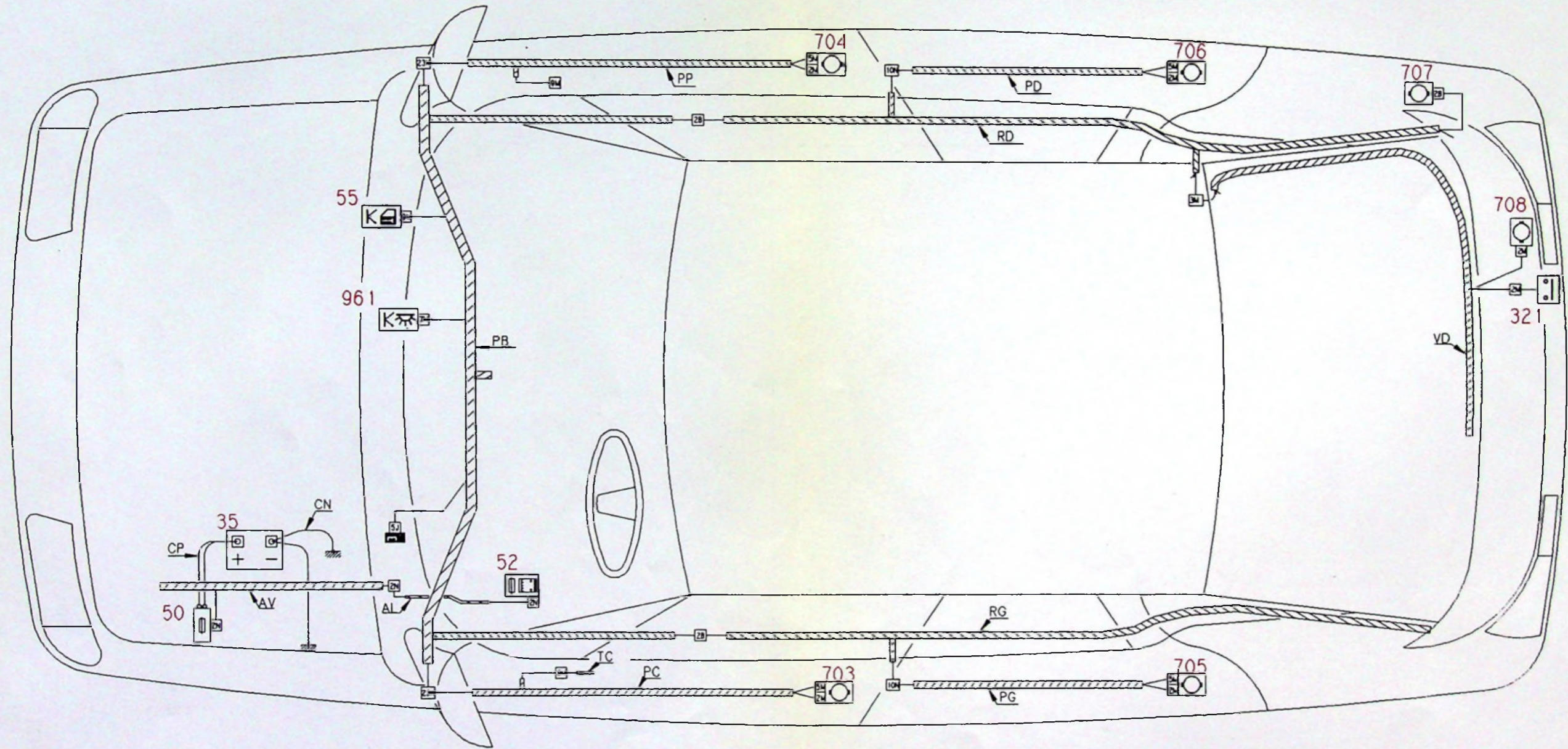



67



XM
672-00/05

5

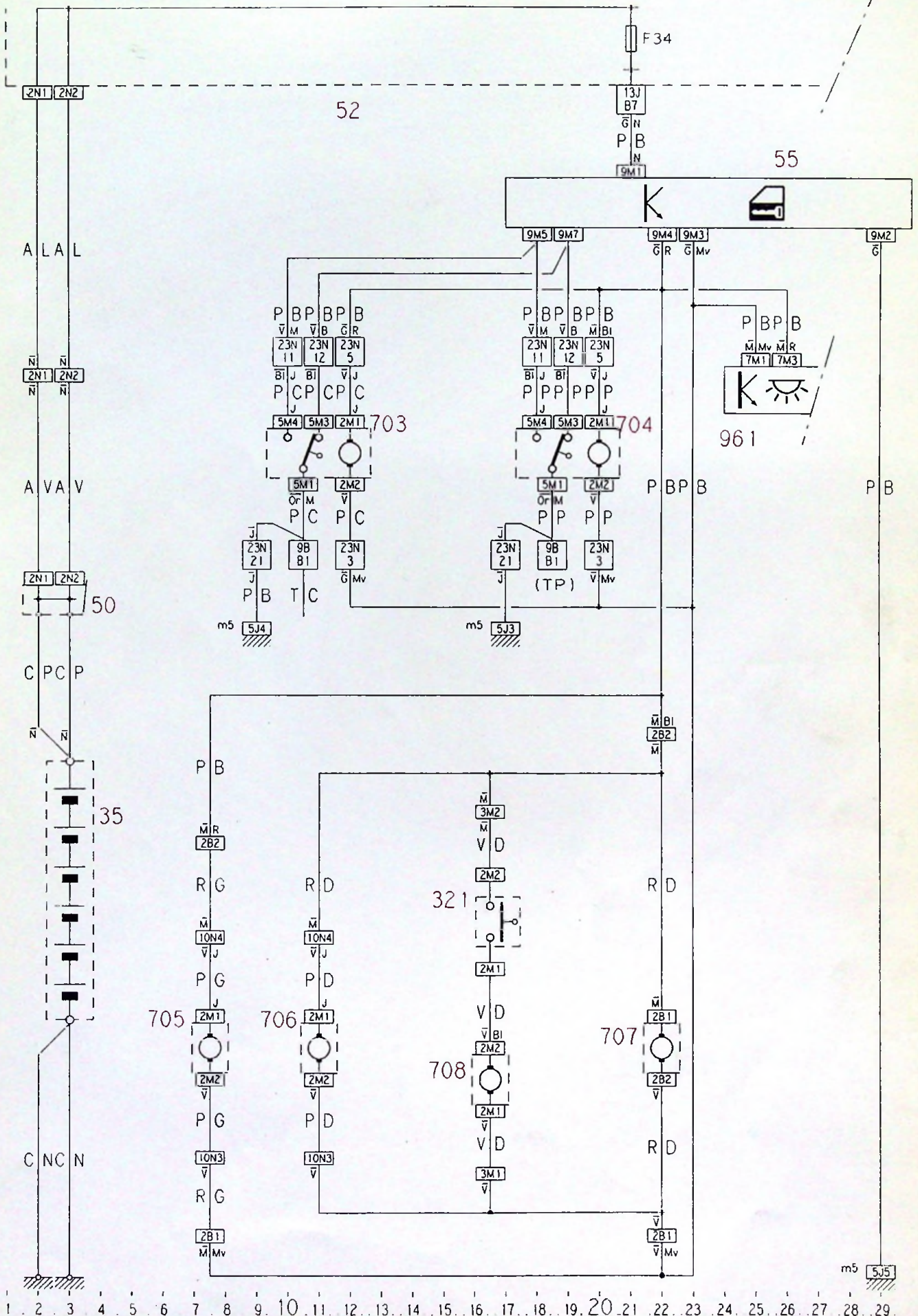

672-00/05



67



XM
672-00/10

1

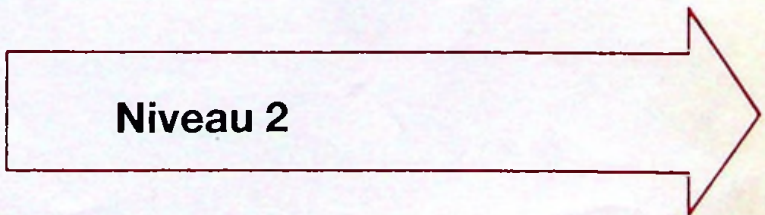

Niveau 2



67



XM
672-00/10

3

4

XM
672-00/10



67

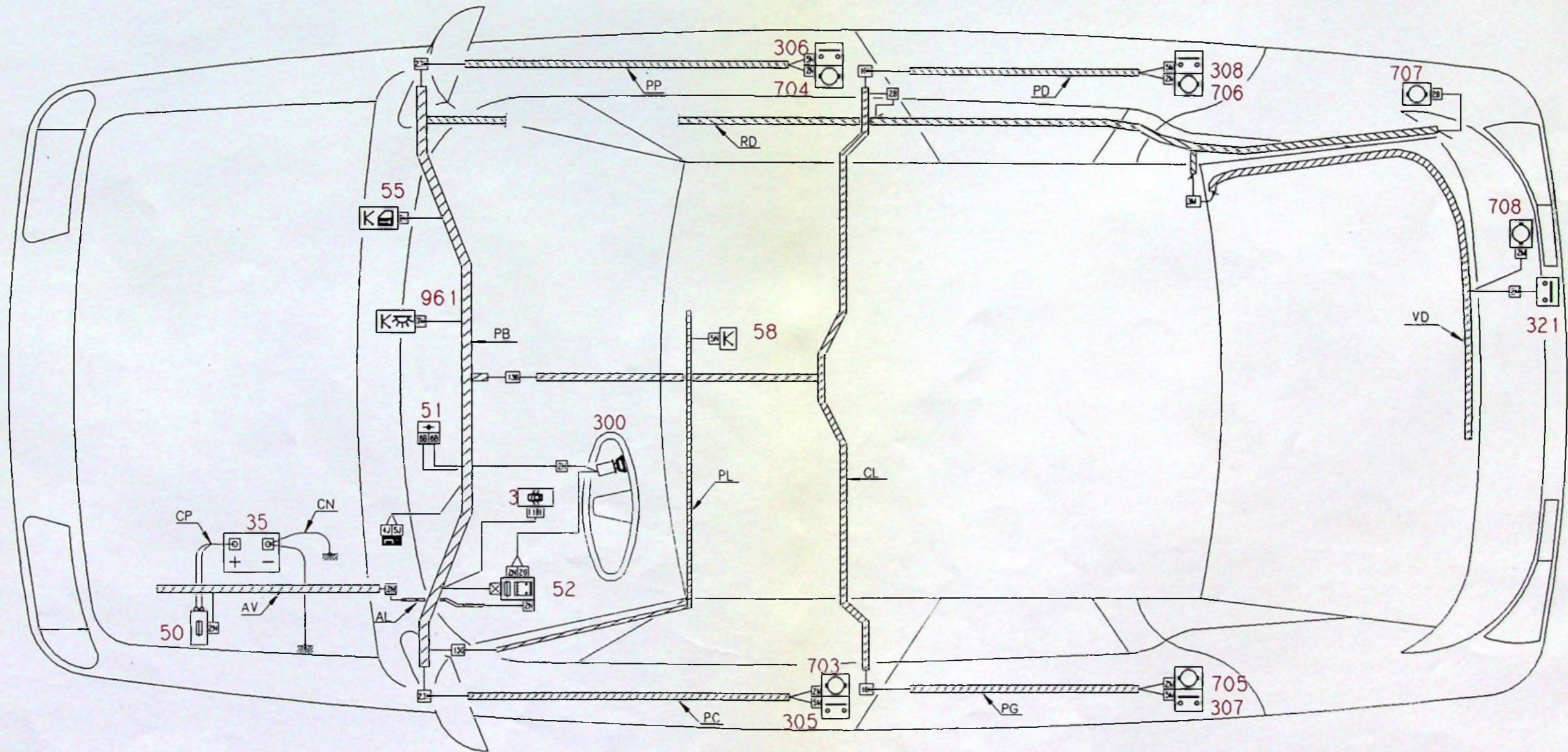



67



XM
672-00/10

5

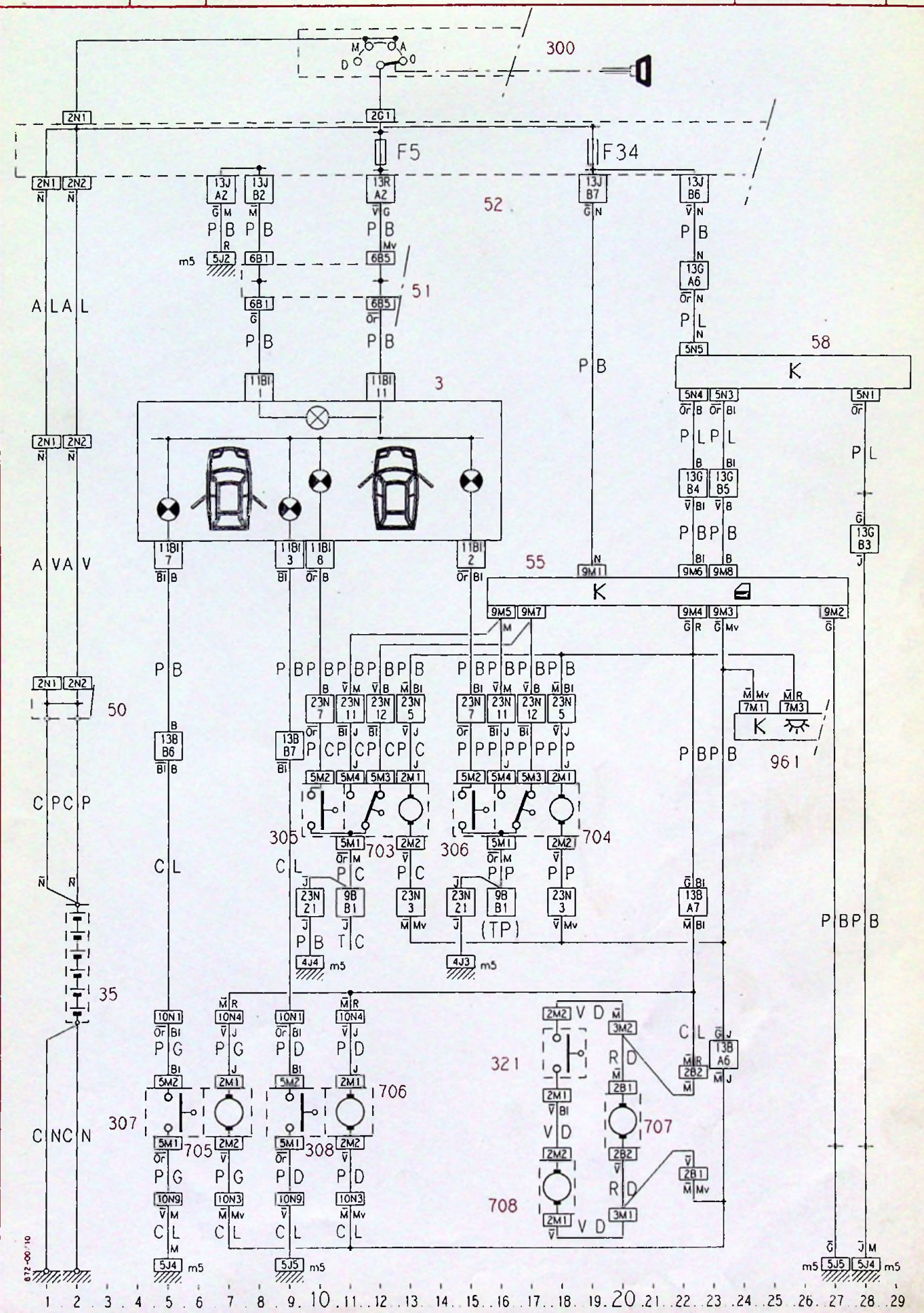

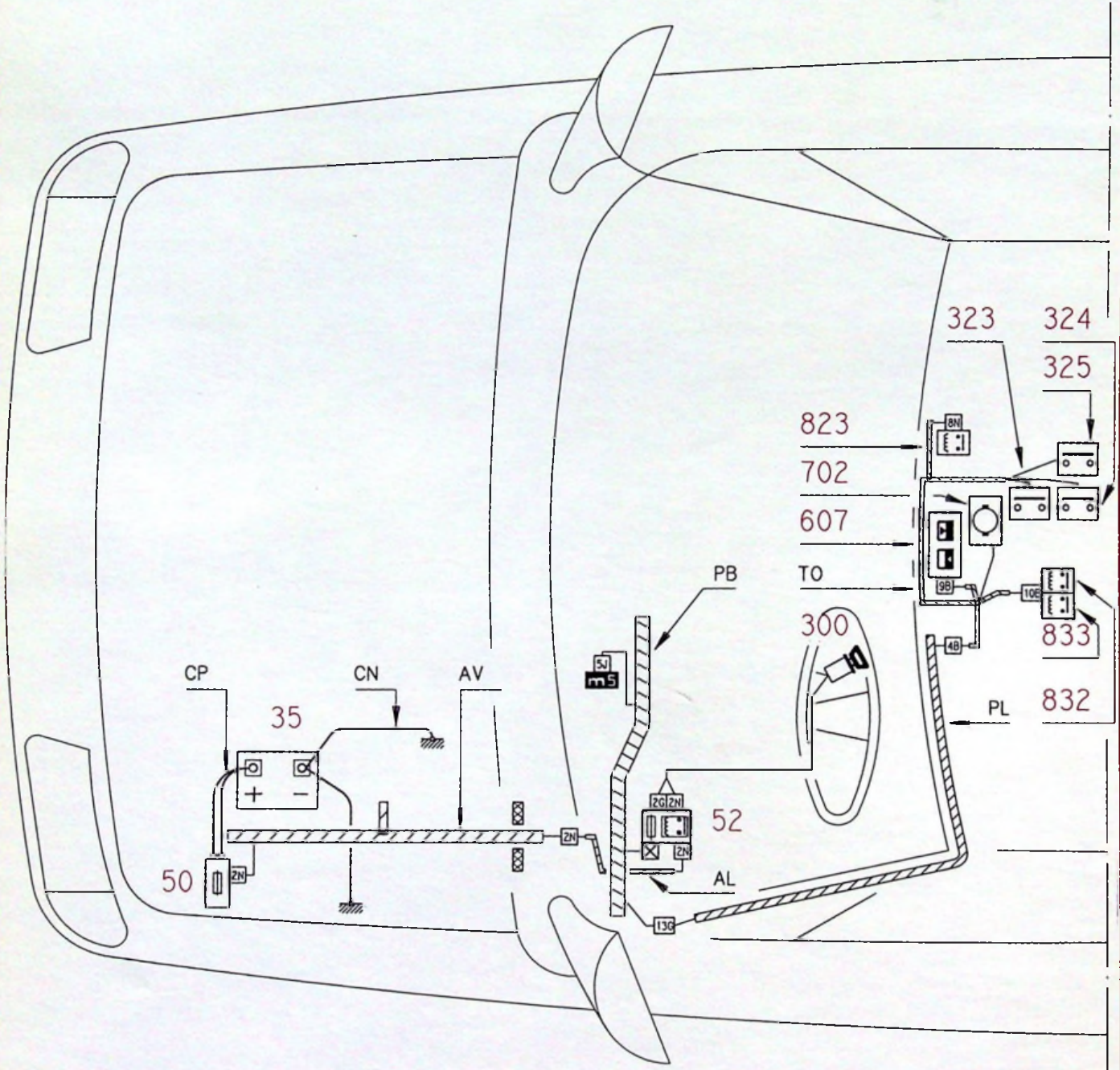



67



XM
673-00/20

3

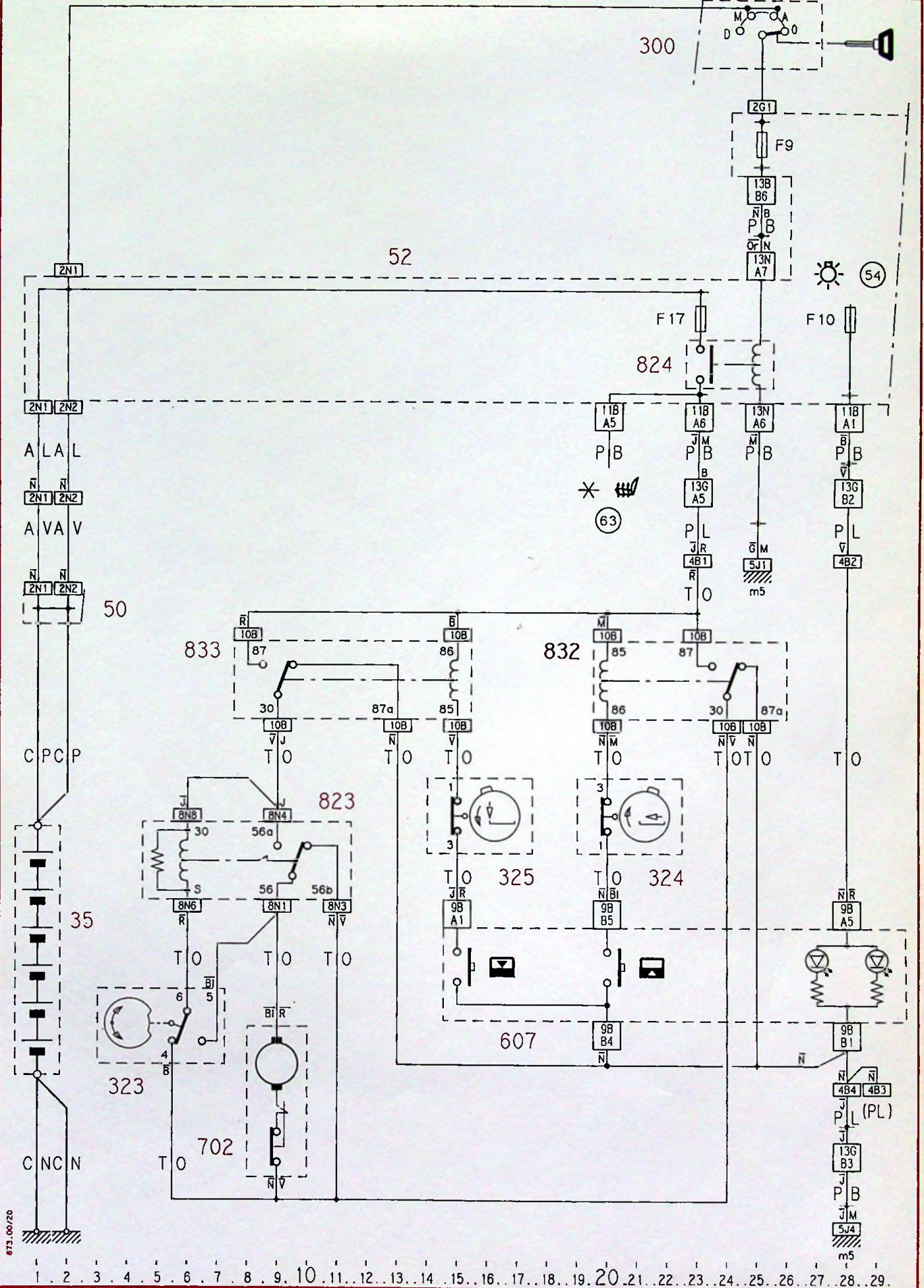

673.00/20

1 2 3 4 5 6 7 8 9 10 11 12 13 14 15 16 17 18 19 20 21 22 23 24 25 26 27 28 29



67



XM
675-0/10

6

7

XM
675-0/10



67

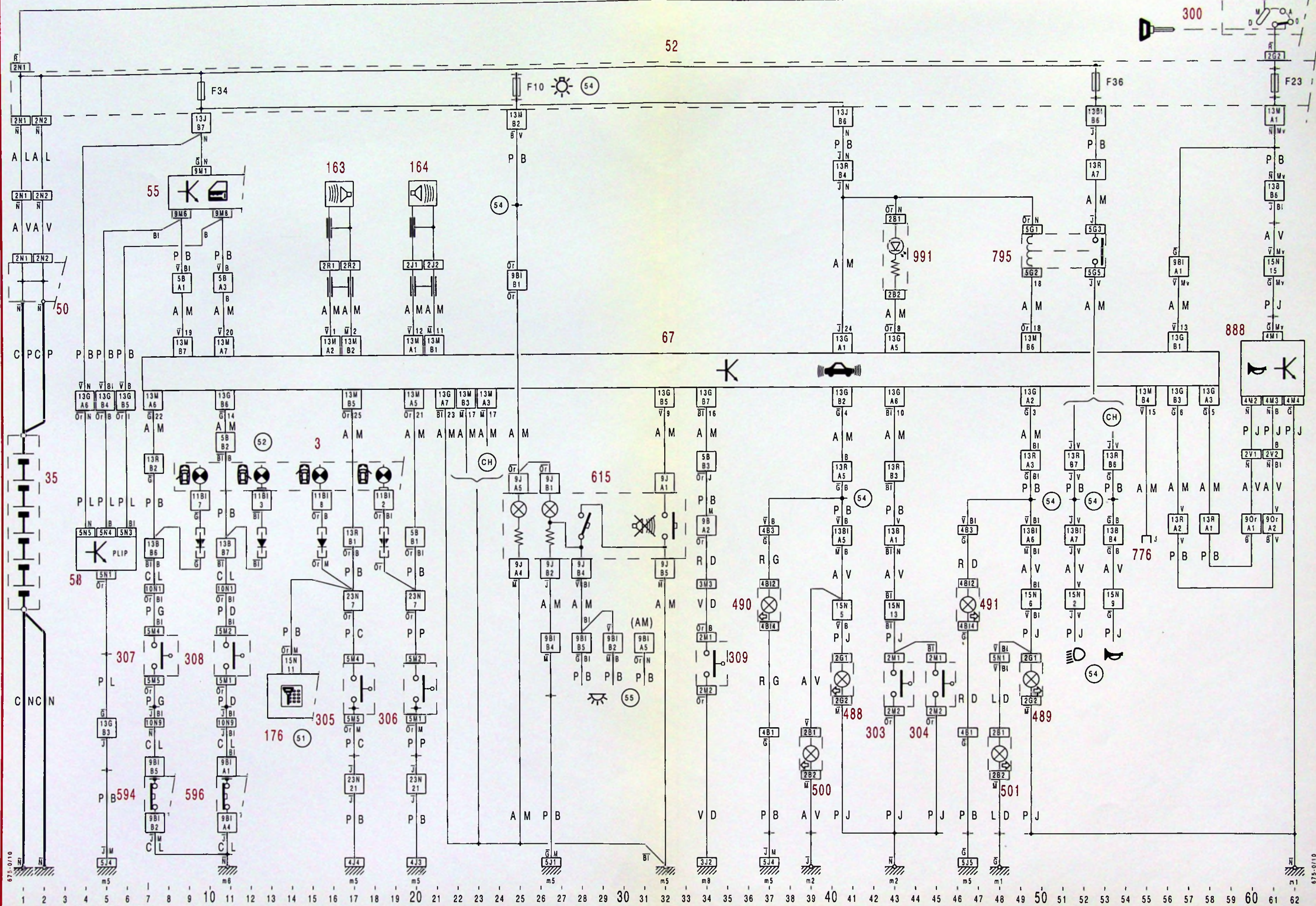



67



XM
675-0/30

6

7

XM
675-0/30



67

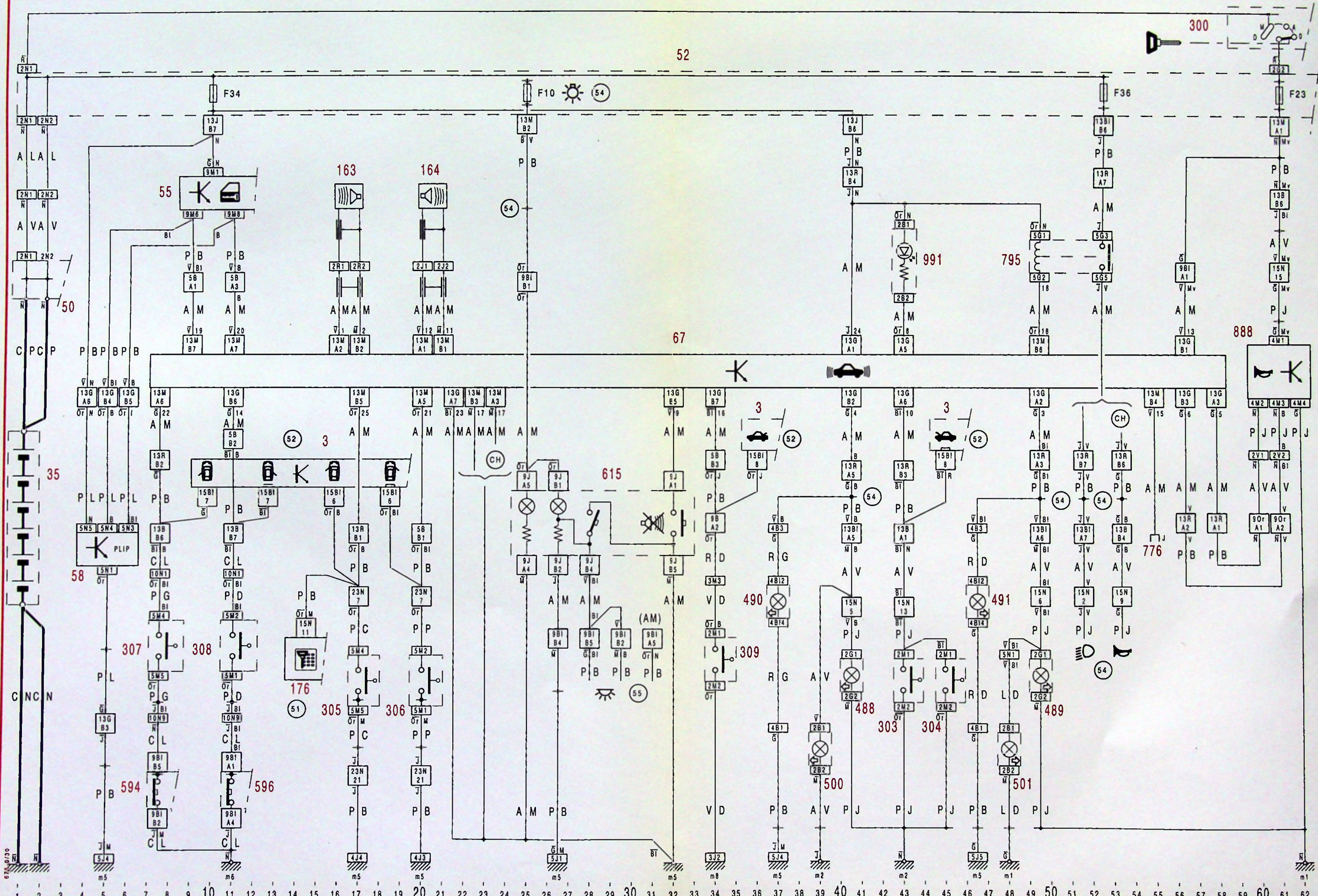

675-0/30

675-0/30